

# **INNOLUX DISPLAY CORPORATION**

## LCD MODULE

# **SPECIFICATION**

Customer: \_\_\_\_\_

Model Name: AT070TN83

SPEC NO.: A070-83-TT-01

Date: 2006/08/02

Version: 01

- Preliminary Specification
- Final Specification

<b>Option</b>
<input checked="" type="checkbox"/> AT070TN83 LCM
<input checked="" type="checkbox"/> T-CON Board (TTL)

**For Customer's Acceptance**

Approved by	Comment

Approved by	Reviewed by	Prepared by
		

### Record of Revision

Version	Revise Date	Page	Content
1	2006/08/02		Initial release.

## Contents

1. General Specifications .....	1
2. Pin Assignment .....	2
2.2 Backlight Unit Section .....	4
3. Operation Specifications .....	5
3.1. Absolute Maximum Rating .....	5
3.1.1. Typical Operation Conditions .....	6
3.1.2. Backlight Driving Conditions .....	7
3.2. Power Sequence .....	8
3.3. Timing Characteristics .....	9
3.3.1. Timing Conditions .....	9
3.3.2. Timing Diagram .....	11
4. Optical Specifications .....	13
5. Reliability Test Items .....	17
6. General Precautions .....	18
6.1. Safety .....	18
6.2. Handling .....	18
6.3. Static Electricity .....	18
6.4. Storage .....	18
6.5. Cleaning .....	18
7. Mechanical Drawing .....	19
8. Package Drawing .....	20
8.1. Packaging Material Table .....	20
8.2. Packaging Quantity .....	20
8.3. Packaging Drawing .....	21

# 1. General Specifications

No.	Item	Specification	Remark
1	LCD size	7.0 inch(Diagonal)	
2	Driver element	a-Si TFT active matrix	
3	Resolution	800X3(RGB)X480	
4	Display mode	Normally white, Transmissive	
5	Dot pitch	0.0635(W)X0.1905(H) mm	
6	Active area	152.4 (W)X91.44 (H) mm	
7	Module size	165(W)X104(H)X5.5(D) mm	Note 1
8	Surface treatment	Anti-Glare	
9	Color arrangement	RGB-stripe	
10	Interface	Digital(TTL)	
11	Backlight power consumption	TBD	
12	Panel power consumption	TBD	
13	Weight	TBD	

Note 1: Refer to Mechanical Drawing.

## 2. Pin Assignment

### 2.1 LCD Panel Driving Section

Pin No.	Symbol	I/O	Function	Remark
1	GND	P	Power ground	
2	GND	P	Power ground	
3	NC	-	No Connection	
4	VCC	I	Power supply for digital circuit	
5	VCC	I	Power supply for digital circuit	
6	VCC	I	Power supply for digital circuit	
7	VCC	I	Power supply for digital circuit	
8	NC	-	No Connection	
9	DE	I	Data enable	
10	GND	P	Power ground	
11	GND	P	Power ground	
12	GND	P	Power ground	
13	B5	I	Blue data input (MSB)	
14	B4	I	Blue data input	
15	B3	I	Blue data input	
16	GND	P	Power ground	
17	B2	I	Blue data input	
18	B1	I	Blue data input	
19	B0	I	Blue data input(LSB)	
20	GND	P	Power ground	

21	G5	I	Green data input(MSB)	
22	G4	I	Green data input	
23	G3	I	Green data input	
24	GND	P	Power ground	
25	G2	I	Green data input	
26	G1	I	Green data input	
27	G0	I	Green data input(LSB)	
28	GND	P	Power ground	
29	R5	I	Red data input(MSB)	
30	R4	I	Red data input	
31	R3	I	Red data input	
32	GND	P	Power ground	
33	R2	I	Red data input	
34	R1	I	Red data input	
35	R0	I	Red data input(LSB)	
36	GND	P	Power ground	
37	GND	P	Power ground	
38	DCLK	I	Sample clock	
39	GND	P	Power ground	
40	GND	P	Power ground	

I: input, O: output, P: Power

## 2.2 Backlight Unit Section

Pin No.	Symbol	I/O	Function	Remark
1	HI	P	Power supply for backlight unit(High voltage)	Pink
2	GND	P	Ground for backlight unit	White

### 3. Operation Specifications

#### 3.1. Absolute Maximum Rating

(GND=AV<sub>SS</sub>=0V, Note 2)

Item	Symbol	Values		Unit	Remark
		Min.	Max.		
Power voltage	V <sub>CC</sub>	-0.3	6.0	V	
Input signal voltage	V <sub>i</sub>	-0.3	6.3	V	Note 1
Operation Temperature	T <sub>OP</sub>	(-20)	(70)	°C	
Storage Temperature	T <sub>ST</sub>	(-30)	(80)	°C	

Note 1: DCLK, DE, R0~ R5, G0~ G5, B0~ B5.

Note 2: The absolute maximum rating values of this product are not allowed to be exceeded at any times. Should a module be used with any of the absolute maximum ratings exceeded, the characteristics of the module may not be recovered, or in an extreme case, the module may be permanently destroyed.



**3.1.1. Typical Operation Conditions**

 (GND=AV<sub>SS</sub>=0V)

Item	Symbol	Values			Unit	Remark
		Min.	Typ.	Max.		
Power voltage	V <sub>CC</sub>	3.0	3.3	3.6	V	Note 1
Current Consumption	I <sub>CC</sub>	-	TBD	-	mA	
Input logic high voltage	V <sub>IH</sub>	0.7V <sub>CC</sub>	-	V <sub>CC</sub>	V	Note 2
Input logic low voltage	V <sub>IL</sub>	0	-	0.3V <sub>CC</sub>	V	

Note 1: V<sub>CC</sub> setting should match the signals output voltage (refer to Note 2) of customer's system board .

Note 2: DCLK,DE,R0~ R5,,G0~ G5,B0~ B5.

**3.1.2. Backlight Driving Conditions**

Item	Symbol	Values			Unit	Remark
		Min.	Typ.	Max.		
LED voltage	$V_L$	-	9.6	12	V	Note 2
LED current	$I_L$	-	20	-	mA	Note 2
LED life time	-	20,000	-	-	Hr	Note 1

Note 1: The “LED life time” is defined as the module brightness decrease to 50% original brightness that the ambient temperature is 25°C and  $I_L = 20\text{mA}$ .

Note 2: The LED driving condition is defined for each LED module.( 3 LED Serial)

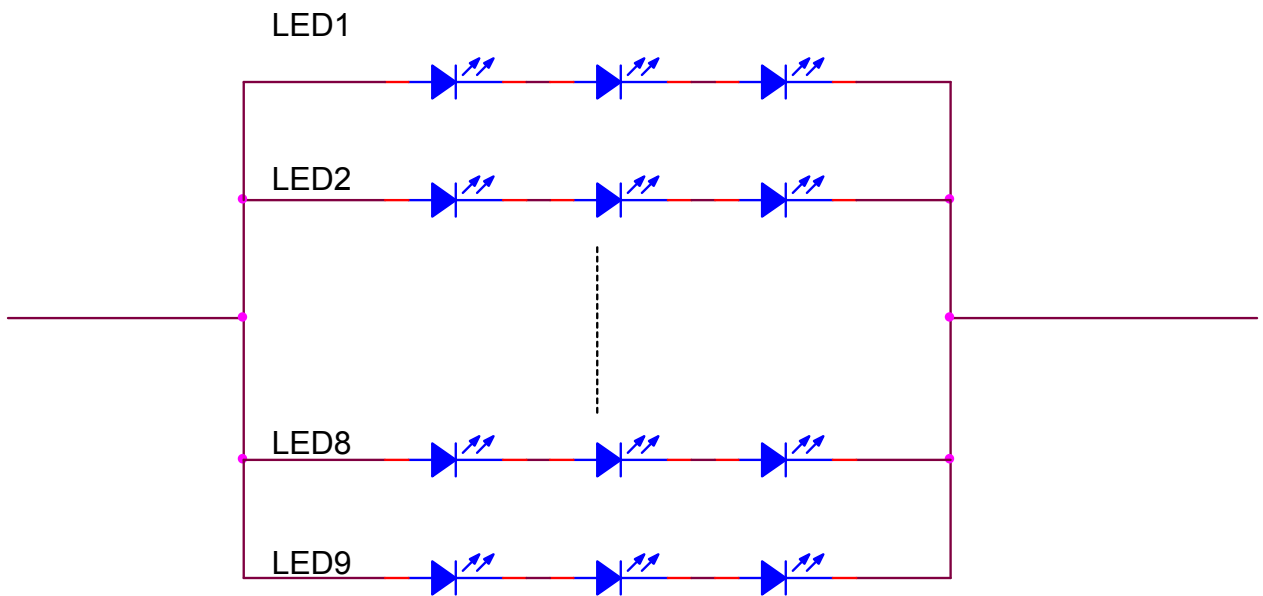

### 3.2. Power Sequence

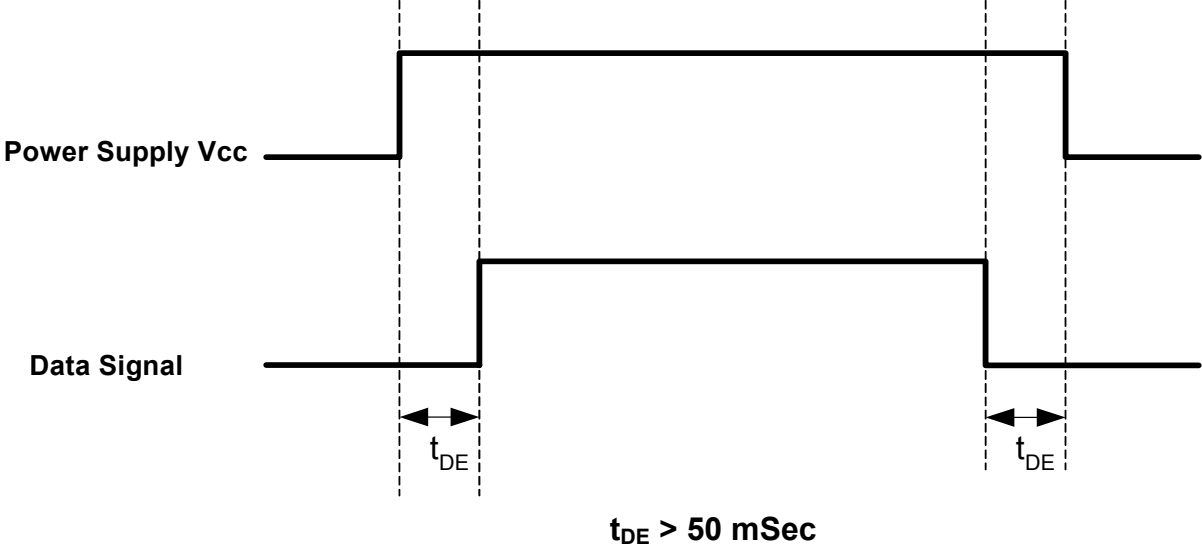

### 3.3. Timing Characteristics

#### 3.3.1. Timing Conditions

##### SYNC mode Input signal characteristics ( 800 x 480 )

Item	Symbol	Values			Unit	Remark
		Min.	Typ.	Max.		
Clock Period	t <sub>CLK</sub>	20.0	30.0	-	ns	
Clock Frequency	f <sub>CLK</sub>	-	33.3	50	MHz	
Clock Low Level Width	t <sub>WCL</sub>	8	-	-	ns	
Clock High Level Width	t <sub>WCH</sub>	8	-	-		
Clock Rise/Fall Time	t <sub>CLKr</sub> , t <sub>CLKf</sub>	-	-	3		
HSYNC Period	t <sub>HP</sub>	-	928	-	t <sub>CLK</sub>	
HSYNC Pulse Width	t <sub>HW</sub>	-	48	-	t <sub>CLK</sub>	
HSYNC Back Porch	t <sub>HBP</sub>	-	40	-	t <sub>CLK</sub>	
HSYNC Width + Back Porch	t <sub>HW</sub> + t <sub>HBP</sub>	88			t <sub>CLK</sub>	
Horizontal valid data width	t <sub>HV</sub>	800			t <sub>CLK</sub>	
HSYNC Front Porch	t <sub>HFP</sub>	t <sub>HP</sub> - t <sub>HW</sub> - t <sub>HBP</sub> - t <sub>HV</sub>			t <sub>CLK</sub>	
Horizontal Blank	t <sub>HBK</sub>	t <sub>HP</sub> - t <sub>HV</sub>			t <sub>CLK</sub>	
VSYNC Period	t <sub>VP</sub>	-	525	-	t <sub>HP</sub>	
VSYNC Pulse Width	t <sub>VW</sub>	-	3	-	t <sub>HP</sub>	
VSYNC Back Porch	t <sub>VBP</sub>	29			t <sub>HP</sub>	
Vertical valid data width	t <sub>v</sub>	480			t <sub>HP</sub>	
Vertical Front Porch	t <sub>VFP</sub>	t <sub>VP</sub> - t <sub>VW</sub> - t <sub>VBP</sub> - t <sub>v</sub>			t <sub>HP</sub>	
Vertical Blank	t <sub>VBK</sub>	t <sub>VP</sub> - t <sub>v</sub>			t <sub>HP</sub>	
Data Setup Time	t <sub>DS</sub>	5	-	-	ns	
Data Hold Time	t <sub>DH</sub>	10	-	-	ns	

**DE mode Input signal characteristics ( 800 x 480 )**

Item	Symbol	Values			Unit	Remark	
		Min.	Typ.	Max.			
DCLK	Period	$t_{CLK}$	20.0	30.0	-	ns	
	Frequency	$f_{CLK}$	-	33.3	50	MHz	
	Low Level Width	$t_{WCL}$	6	-	-	ns	
	High Level Width	$t_{WCH}$	6	-	-		
	Rise/Fall Time	$t_{CLKr}, t_{CLKf}$	-	-	3		
	Duty	-	0.45	0.50	0.55	-	$t_{CLKL} / t_{CLK}$
DE	Setup Time	$t_{DES}$	5	-	-	ns	
	Hold Time	$t_{DEH}$	10	-	-		
	Rise/Fall Time	$t_{DEr}, t_{DEf}$	-	-	16		
	Horizontal Period	$t_{HP}$	-	928	-	$t_{CLK}$	
	Horizontal Valid	$t_{HV}$	800				
	Horizontal Blank	$t_{HBK}$	$t_{HP} - t_{HV}$				
	Vertical Period	$t_{VP}$	-	525	-	$t_{HP}$	
	Vertical Valid	$t_w$	480				
	Vertical Blank	$t_{VBK}$	$t_{VP} - t_w$				
DATA	Setup Time	$t_{DS}$	5	-	-	ns	
	Hold Time	$t_{DH}$	10	-	-		
	Rise/Fall Time	$t_{Dr}, t_{Df}$	-	-	3		

**3.3.2. Timing Diagram**

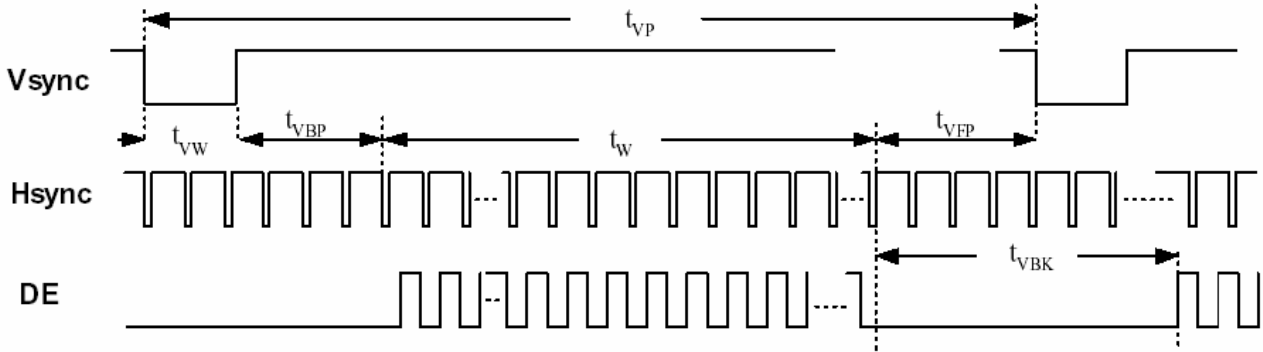

**Input Vertical Timing**

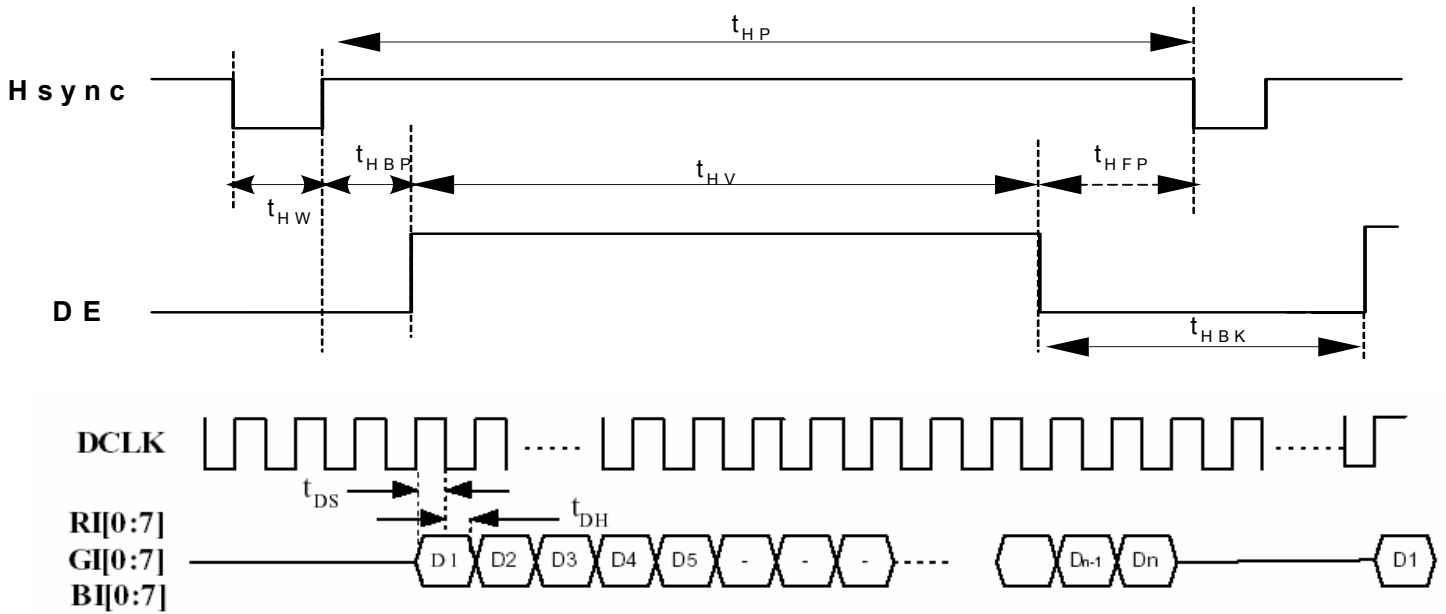

**Input Horizontal Timing**

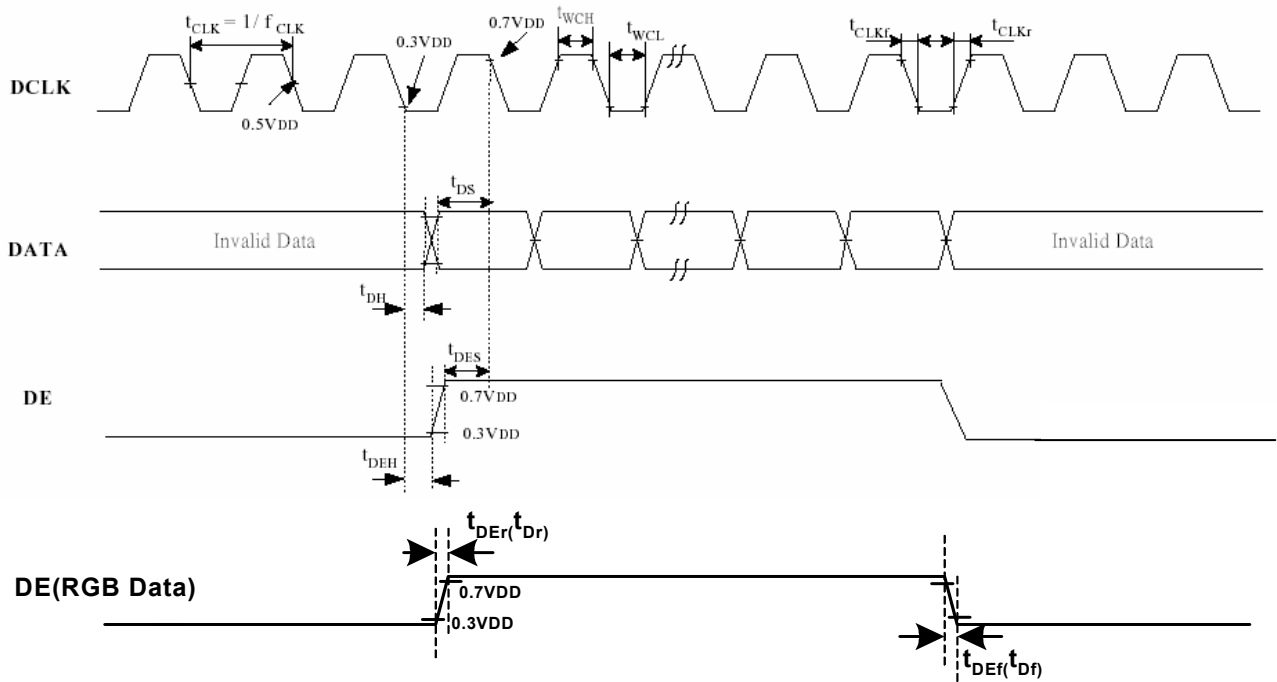

**DE and RGB Input Timing**

## 4. Optical Specifications

Item	Symbol	Condition	Values			Unit	Remark
			Min.	Typ.	Max.		
Viewing angle (CR≥ 10)	$\theta_L$	$\Phi=180^\circ$ (9 o'clock)	(60)	(70)	-	degree	Note 1
	$\theta_R$	$\Phi=0^\circ$ (3 o'clock)	(60)	(70)	-		
	$\theta_T$	$\Phi=90^\circ$ (12 o'clock)	(40)	(50)	-		
	$\theta_B$	$\Phi=270^\circ$ (6 o'clock)	(60)	(70)	-		
Response time	$T_{ON}$	Normal $\theta=\Phi=0^\circ$	-	(10)	(20)	msec	Note 3
	$T_{OFF}$		-	(15)	(30)	msec	Note 3
Contrast ratio	CR		(400)	(500)	-	-	Note 4
Color chromaticity	$W_X$		(0.26)	(0.31)	(0.36)	-	Note 2 Note 5 Note 6
	$W_Y$		(0.28)	(0.33)	(0.38)		
Luminance	L		(250)	(300)	-		Note 6
Luminance uniformity	$Y_U$		70	75	-	%	Note 7

**Test Conditions:**

1.  $V_{CC}=3.3V$ ,  $I_L=20mA$  (Backlight current), the ambient temperature is  $25^\circ C$ .
2. The test systems refer to Note 2.



Note 1: Definition of viewing angle range

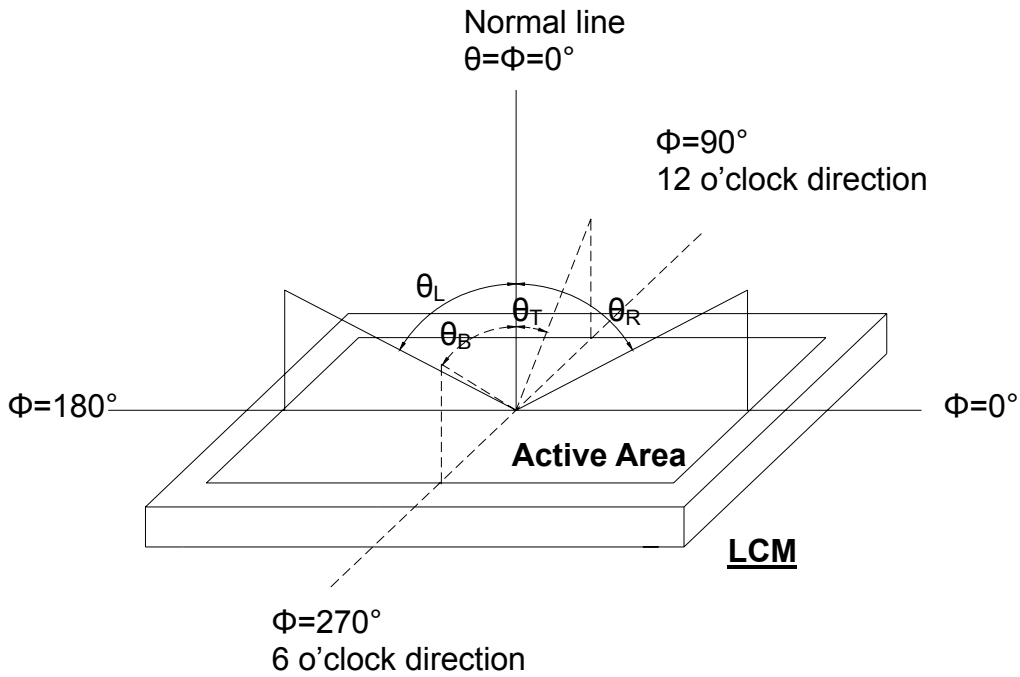

Fig. 4-1 Definition of viewing angle

Note 2: Definition of optical measurement system.

The optical characteristics should be measured in dark room. After 30 minutes operation, the optical properties are measured at the center point of the LCD screen. (Response time is measured by Photo detector TOPCON BM-7, other items are measured by BM-5A/Field of view:  $1^\circ$  /Height: 500mm.)

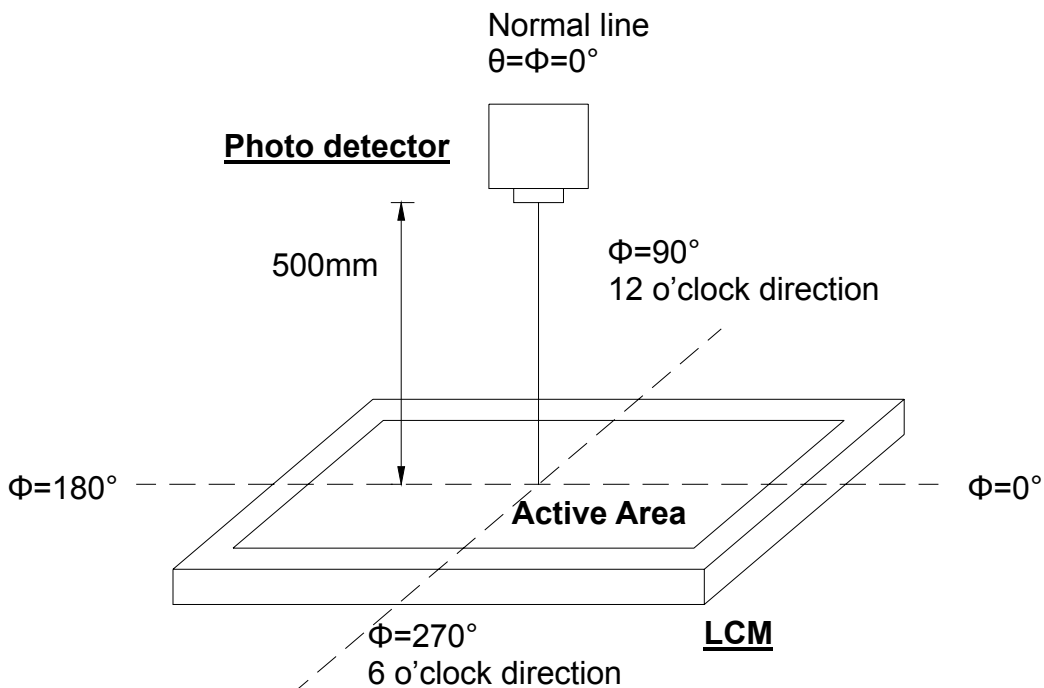

Fig. 4-2 Optical measurement system setup

Note 3: Definition of Response time

The response time is defined as the LCD optical switching time interval between "White" state and "Black" state. Rise time ( $T_{ON}$ ) is the time between photo detector output intensity changed from 90% to 10%. And fall time ( $T_{OFF}$ ) is the time between photo detector output intensity changed from 10% to 90%.

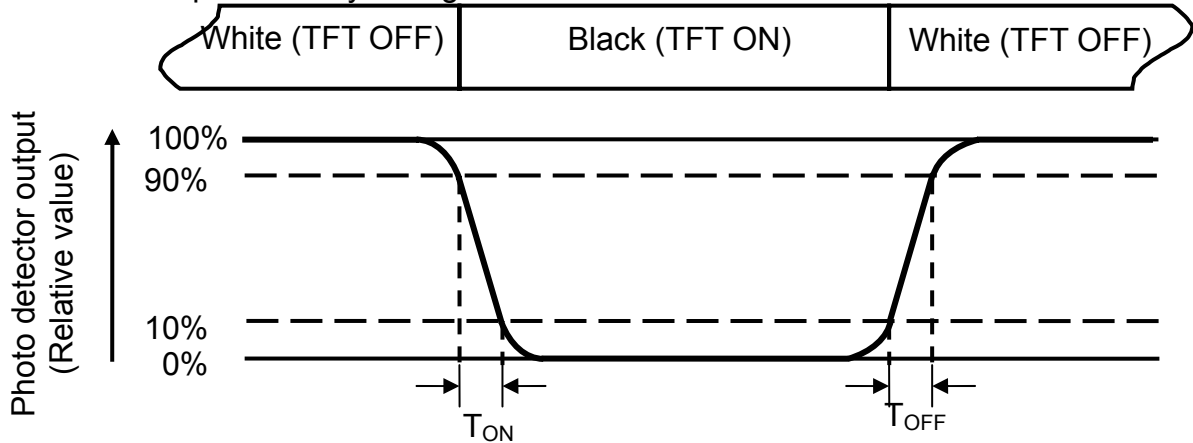

Fig. 4-3 Definition of response time

Note 4: Definition of contrast ratio

$$\text{Contrast ratio (CR)} = \frac{\text{Luminance measured when LCD on the "White" state}}{\text{Luminance measured when LCD on the "Black" state}}$$

Note 5: Definition of color chromaticity (CIE1931)

Color coordinates measured at center point of LCD.

Note 6: All input terminals LCD panel must be ground while measuring the center area of the panel.

Note 7: Definition of Luminance Uniformity

Active area is divided into 9 measuring areas (Refer to Fig. 4-4 ).Every measuring point is placed at the center of each measuring area.

$$\text{Luminance Uniformity (Yu)} = \frac{B_{min}}{B_{max}}$$

L-----Active area length      W----- Active area width

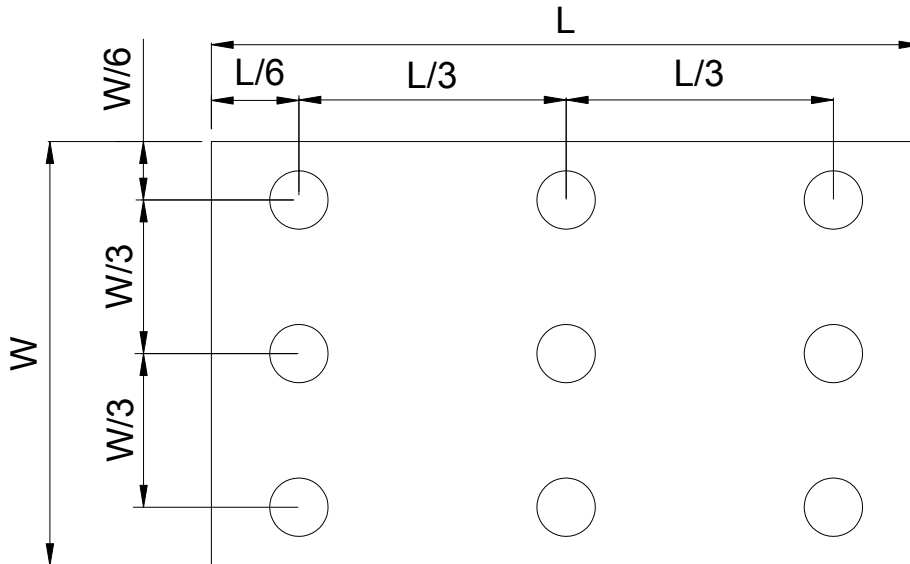

Fig. 4-4 Definition of measuring points

**B<sub>max</sub>**: The measured maximum luminance of all measurement position.

**B<sub>min</sub>**: The measured minimum luminance of all measurement position.

## 5. Reliability Test Items

(Note3)

Item	Test Conditions	Remark
High Temperature Storage	Ta = (80)°C                                  240 hrs	Note 1
Low Temperature Storage	Ta = (-30)°C                                  240hrs	Note 1
High Temperature Operation	Ts = (70)°C                                  240hrs	Note 2
Low Temperature Operation	Ta =(-20)°C                                  240hrs	Note 1
Operate at High Temperature and Humidity	+40°C, 90%RH max.                          240 hrs	
Thermal Shock	(-30)°C/30 min ~ (+80)°C/30 min for a total 100 cycles, Start with cold temperature and end with high temperature.	
Vibration Test	Frequency range:10~55Hz Stroke:1.5mm Sweep:10Hz~55Hz~10Hz 2 hours for each direction of X. Y. Z. (6 hours for total)	
Mechanical Shock	100G 6ms,±X, ±Y, ±Z 3 times for each direction	
Package Vibration Test	Random Vibration : 0.015G*G/Hz from 5-200HZ, -6dB/Octave from 200-500HZ 2 hours for each direction of X. Y. Z. (6 hours for total)	
Package Drop Test	Height:60 cm 1 corner, 3 edges, 6 surfaces	
Electro Static Discharge	± 2KV, Human Body Mode, 100pF/1500Ω	

Note 1: Ta is the ambient temperature of samples.

Note 2: Ts is the temperature of panel's surface.

Note 3: In the standard condition, there shall be no practical problem that may affect the display function. After the reliability test, the product only guarantees operation, but doesn't guarantee all the cosmetic specification.

## 6. General Precautions

### 6.1. Safety

Liquid crystal is poisonous. Do not put it in your mouth. If liquid crystal touches your skin or clothes, wash it off immediately by using soap and water.

### 6.2. Handling

1. The LCD panel is plate glass. Do not subject the panel to mechanical shock or to excessive force on its surface.
2. The polarizer attached to the display is easily damaged. Please handle it carefully to avoid scratch or other damages.
3. To avoid contamination on the display surface, do not touch the module surface with bare hands.
4. Keep a space so that the LCD panels do not touch other components.
5. Put cover board such as acrylic board on the surface of LCD panel to protect panel from damages.
6. Transparent electrodes may be disconnected if you use the LCD panel under environmental conditions where the condensation of dew occurs.
7. Do not leave module in direct sunlight to avoid malfunction of the ICs.

### 6.3. Static Electricity

1. Be sure to ground module before turning on power or operating module.
2. Do not apply voltage which exceeds the absolute maximum rating value.

### 6.4. Storage

1. Store the module in a dark room where must keep at  $25\pm 10^{\circ}\text{C}$  and 65%RH or less.
2. Do not store the module in surroundings containing organic solvent or corrosive gas.
3. Store the module in an anti-electrostatic container or bag.

### 6.5. Cleaning

1. Do not wipe the polarizer with dry cloth. It might cause scratch.
2. Only use a soft sloth with IPA to wipe the polarizer, other chemicals might permanent damage to the polarizer.

# 7. Mechanical Drawing

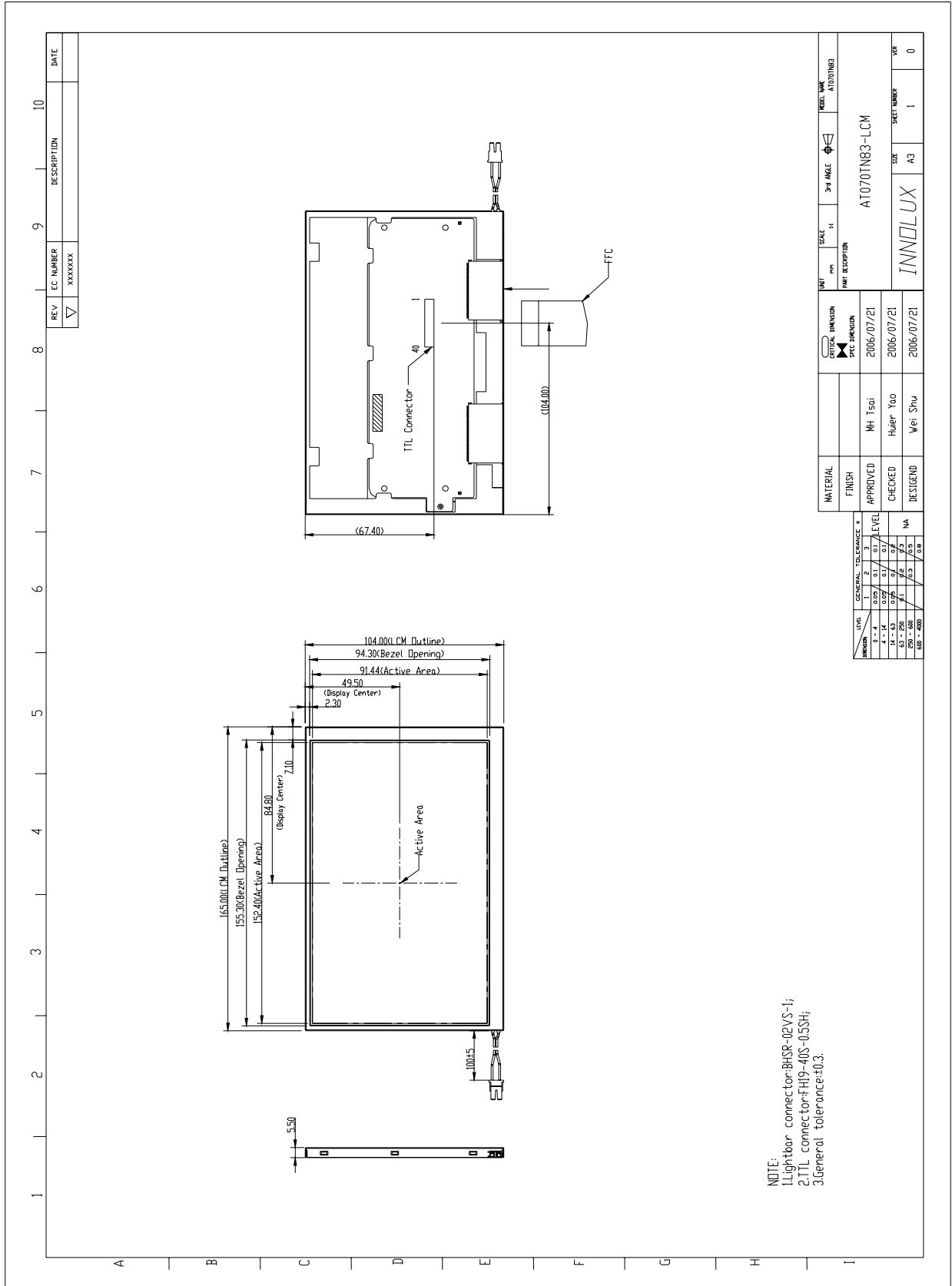

## 8. Package Drawing

### 8.1. Packaging Material Table

No.	Item	Model (Material)	Dimensions(mm)	Unit Weight (kg)	Quantity	Remark
1	LCM Module	AT070TN83	165X104X5.5	TBD	50pcs	
2	Partition	BC Corrugated Paper	512×349×226	1.466	1 set	
3	Corrugated Bar	B Corrugated Paper	512X11X3	0.046	4 set	
4	Dust-Proof Bag	PE	700X530	0.048	1 pcs	
5	A/S Bag	PE	180×160×0.05	0.002	50 pcs	
6	Carton	Corrugated paper	530*355*255	1.100	1 pcs	
7	Total weight	TBD				

### 8.2. Packaging Quantity

Total LCM quantity in Carton: no. of Partition 2 Rows x quantity per Row 25 = 50
--

### **8.3. Packaging Drawing**

**TBD**