



# TFT COLOR LCD MODULE

**Type: NL8060BC31-17D**  
**31 cm (12,1 Type), SVGA**

**antiglare polarizer**  
**high luminance (Typ 350 cd/m<sup>2</sup>)**  
**wide viewing angle**

## SPECIFICATIONS

(First Edition)

**PRELIMINARY**

This document is preliminary. All information in this document are subject to change without prior notice

<b>NEC Corporation</b> <b>NEC Electron Devices</b> <b>Display Device Operations Unit</b> <b>Color LCD Division</b> <b>Application Engineering Department</b>		
<b>Approved</b>		<b>Jan.24</b> <b>2001</b>
<b>Checked</b>		<b>Jan.24</b> <b>2001</b>
<b>Prepared</b>		<b>Jan.24</b> <b>2001</b>

No part of this document may be copied or reproduced in any form or by any means without the prior written consent of NEC Corporation. NEC Corporation assumes no responsibility for any errors, which may appear in this document.

NEC Corporation does not assume any liability for infringement of patents, copyrights or other intellectual property rights of third parties by or arising from use of a device. No license, either express, implied or otherwise, is granted under any patents, copyrights or other intellectual property rights of NEC Corporation or others.

The devices listed in this document are for use of "Standard" applications as specified below, and are not suitable for use of "Special" or "Specific" applications as specified below. NEC disclaims any responsibility or liability of any kind for any failure of equipment, personal injury or damage to property which may arise from the use of NEC devices for such "Special" applications.

The devices listed in this documents should not be used for such "Specific" applications.

Application examples recommended by NEC Corporation.

**Standard:** Computers, office equipment, communications equipment, test and measurement equipment, audio and visual equipment, home electronic appliances, machine tools, personal electronic equipment and industrial robots.

**Special:** Transportation equipment (automobiles, trains, ships, etc.), traffic control systems, anti-disaster systems, anti-crime systems, safety equipment and medical equipment (not specifically designed for life support).

**Specific:** Military systems, aircraft, aerospace equipment, submersible repeaters, nuclear reactor control systems, life support systems or medical equipment for life support, or any other equipment for which specifically high standard of quality or reliability is required.

## 1. DESCRIPTION

NL8060BC31-17D is a TFT (thin film transistor) active matrix color liquid crystal display (LCD) comprising amorphous silicon TFT attached to each signal electrode, a driving circuit and a backlight.

NL8060BC31-17D has a built-in backlight. The backlight includes long-life-lamps and the lamps are replaceable with a holder.

The 31 cm (12.1 Type) diagonal display area contains  $800 \times 600$  pixels and can display 262,144 colors simultaneously.

## 2. FEATURES

- Polarizer surface : antiglare treatment
- Wide viewing angle (with Retardation Film)
- High luminance ( $350\text{cd/m}^2$  at  $\text{IL} = 5\text{mArms}$  / lamp)
- Reversible scan direction (with DPS terminal)
- Data enable (DE) function (auto recognition)
- Easy to assemble a touch panel
- Edge type backlight with two long-life-time lamps ( one lamp holder, inverter-less)
- Replaceable lamp holder : Part No.121LHS15
- Recommended inverter : Part No.121PW111
- 6-bits digital RGB signals
- Approved by UL1950 Third Edition and CSA-C22.2 No.950-95 (No.: E170632)

## 3. APPLICATIONS

- Personal computers (PC) for factory automation
- Display terminals for control system
- Monitors for process controller

## 4. STRUCTURE AND FUNCTIONS

A color TFT (thin film transistor) LCD module is comprised of a TFT liquid crystal panel structure, LSIs for driving the TFT array, and a backlight assembly. Sandwiching liquid crystal material in the narrow gap between a TFT array glass substrate and a color filter glass substrate creates the TFT panel structure. After the driver LSIs are connected to the panel, the backlight assembly is attached to the backside of the panel.

RGB (red, green, blue) data signals from a source system are modulated into a form suitable for active matrix addressing by the onboard signal processor and sent to the driver LSIs which in turn addresses the individual TFT cells.

Acting as an Electro-optical switch, each TFT cell regulates light transmission from the backlight assembly when activated by the data source. By regulating the amount of light passing through the array of red, green, and blue dots, color images are created with clarity.

## 5. OUTLINE OF CHARACTERISTICS (at room temperature)

Display area	246.0 (H)×184.5 (V) mm
Drive system	a-Si TFT active matrix
Display colors	262,144 colors
Number of pixels	800×600
Pixel arrangement	RGB vertical stripe
Pixel pitch	0.3075 (H)×0.3075 (V) mm
Module size	280.0 (H)×210.0 (V)×13.0 (D) mm (Typ.)
Weight	750 g (Typ. )
Contrast ratio	350:1 (Typ. )
Viewing angle (more than the contrast ratio of 10:1)	<ul style="list-style-type: none"> <li>• Horizontal: 55 ° (Typ., left side, right side)</li> <li>• Vertical: 40 ° (Typ., upper side), 50 ° (Typ., lower side)</li> </ul>
Designed viewing direction	<ul style="list-style-type: none"> <li>• Wider viewing angle without image reversal: upper side ( 12 o'clock, normal scan)</li> <li>• Wider viewing angle with contrast ratio: lower side ( 6 o'clock, normal scan)</li> <li>• Optimum grayscale ( <math>\gamma = 2.2</math>): perpendicular</li> </ul>
Polarizer pencil-hardness	2 H (Min., at JIS K5400)
Color gamut	43 % (Typ., at center, To NTSC)
Response time	15 ms (Typ.), "white" to "black"
Luminance	350 cd/m <sup>2</sup> (Typ., at IL= 5mArms / lamp)
Signal system	RGB 6-bit signals, Synchronous signals (Hsync, Vsync), Dot clock (CLK)
Backlight	Edge light type: Two cold cathode fluorescent lamps in a holder <b>【Replaceable parts】</b> <ul style="list-style-type: none"> <li>• Lamp holder: Part No. 121LHS15</li> <li>• Inverter: Part No. 121PW111</li> </ul>
Supply voltage	3.3V [5 V] (Logic, LCD driving)
Power consumption	7 W (Typ., at IL= 5mArms / lamp)

## 6. BLOCK DIAGRAM

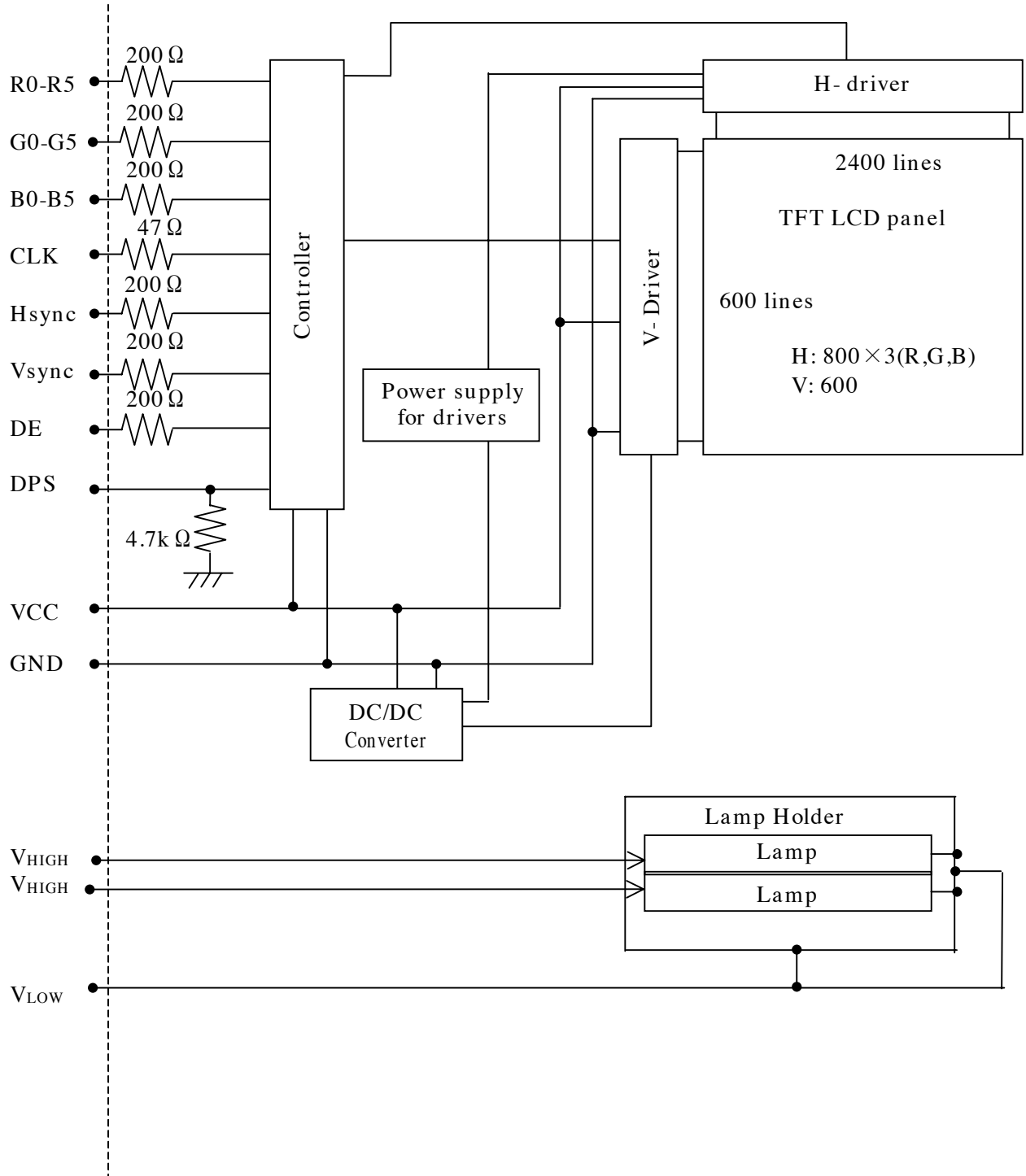

Note 1: GND is not connected to FG (Frame Ground) in the LCD module.

Note 2: V<sub>LOW</sub> is connected to the lamp holder.

Frame is not connected to the lamp holder.

## 7. GENERAL SPECIFICATIONS

Items	Specifications	Unit
Module size	280.0±0.5 (H) × 210.0±0.5 (V) × 13.7 (Max., D)	mm
Display area	246.0 (H) × 184.5 (V) 【 Diagonal display area: 31cm ( Type 12.1) 】	mm
Number of pixels	800×3 (H) × 600 (V)	pixel
Dot pitch	0.1025 (H) × 0.3075 (V)	mm
Pixel pitch	0.3075 (H) × 0.3075 (V)	mm
Pixel arrangement	RGB (Red, Green, Blue) vertical stripe	—
Display colors	262,144	color
Weight	780 (Max.)	g

## 8. ABSOLUTE MAXIMUM RATINGS

(Ta=25°C)

Parameters	Symbols	Ratings	Unit	Remarks
Supply voltage	VCC	-0.3 to +6.5	V	Ta = 25°C
Logic input voltage	VI	-0.3 to VCC+0.3	V	Ta = 25°C
Lamp voltage	VL	1800	Vrms	Ta = 25°C
Storage temperature	Tst	-20 to +60	°C	—
Operating temperature	Top	0 to +50	°C	Module surface Note 1
Relative humidity (RH)		≤ 95	%	Ta ≤ 40°C
Note 2		≤ 85	%	40 < Ta ≤ 50°C
Absolute humidity		Absolute humidity shall not exceed Ta = 50°C, RH = 85%	g/m <sup>3</sup>	Ta > 50°C
Note 2				

Note 1: Measure at the panel surface ( Including self heat)

Note 2: No condensation

## 9. ELECTRICAL CHARACTERISTICS

(1) Logic/ LCD driving

(Ta = 25 ± 2°C)

Parameters	Symbols	Min.	Typ.	Max.	Unit	Remarks
Supply voltage	VCC	3.0 (4.75)	3.3 (5.0)	3.6 (5.25)	V	VCC=3.3V (VCC=5.0V)
Logic input "L" voltage	VIL	0	—	VCC × 0.3	V	CMOS level
Logic input "H" voltage	VIH	VCC × 0.7	—	VCC	V	
Supply current	ICC	—	320 (240) Note 1	600 (500) Note 2	mA	VCC = 3.3V (VCC=5.0V)

Note 1: Checker flag pattern (in EIAJ ED-2522)

Note 2: Theoretical maximum current pattern

## (2) Backlight

(Ta = 25 ± 2°C)

Parameters	Symbols	Min.	Typ.	Max.	Unit	Remarks
Lamp current	IL	2.0 Note 1	5.0	5.5	mArms	at a lamp
Lamp voltage	VL	—	600	—	Vrms	IL=5mA
Lamp turn on voltage Note 2	VS	960	—	—	Vrms	Ta = 25°C
		1200	—	—	Vrms	Ta = 0°C
Oscillator frequency	Ft	58	65	69	kHz	Note 3

Note 1: In an atmosphere of below 10°C, keep the lamp current more than 3.0mArms in order to prevent the lamp from blinking.

Note 2: The phase of the supply voltage for lamps must keep same one.

Note 3: Recommended value of "Ft"

• Ft is within the specification.

and

•  $Ft = 1/4th \times (2n-1)$

th: Hsync period

n: a natural number (1,2,3...)

If Ft is out of the recommended value, interference between Ft frequency and Hsync frequency may cause beat on the display.

## 10. SUPPLY VOLTAGE SEQUENCE

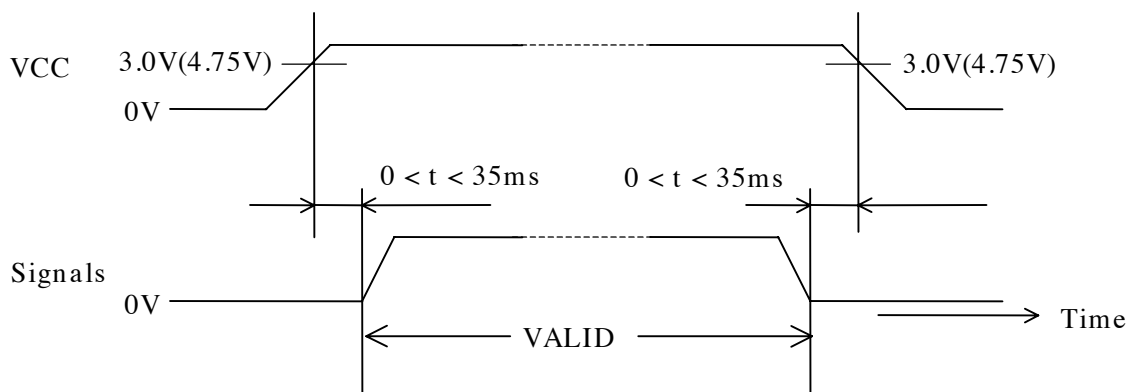

Signals: CLK, Hsync, Vsync, DE, R0-R5, G0-G5, B0-B5

Note1 The supply voltage for input signals should be the same as VCC.

Note2 Turn on the backlight within the LCD operation period. When the backlight turns on before LCD operation or the LCD operation turns off before the backlight turns off, the display may momentarily become white.

Note3 When the power is off, please keep whole signals (Hsync, Vsync, CLK, DE, R0-R5, G0-G5, B0-B5) low level or high impedance.

Note4 Wrong power sequence may damage the module.

Note5 The signals should not be down during operation. Even if the signals could recover, LCD module can not be operated correctly or the display may have un-uniformity. In case the signals is down, VCC should be turned off, and then turn VCC and the signals on with above sequence.

## 11. INTERFACE PIN CONNECTIONS

(1) Interface connector for signal and power

CN1 socket: DF9-41P-1V(HIROSE ELECTRIC CO.,LTD.)

Adaptable plug: DF9-41S-1V (HIROSE ELECTRIC CO.,LTD.)

or

IL-310-T41S-VF (Japan Aviation Electronics Industry Limited (JAE))

Pin No.	Symbols	Functions	Pin No.	Symbols	Functions
1	GND	Ground	22	GND	Ground
2	CLK	Dot clock	23	G3	Green data
3	GND	Ground	24	G4	Green data
4	Hsync	Horizontal sync.	25	G5	Green data (MSB)
5	Vsync	Vertical sync.	26	GND	Ground
6	GND	Ground	27	GND	Ground
7	GND	Ground	28	GND	Ground
8	GND	Ground	29	B0	Blue data (LSB)
9	R0	Red data (LSB)	30	B1	Blue data
10	R1	Red data	31	B2	Blue data
11	R2	Red data	32	GND	Ground
12	GND	Ground	33	B3	Blue data
13	R3	Red data	34	B4	Blue data
14	R4	Red data	35	B5	Blue data (MSB)
15	R5	Red data (MSB)	36	GND	Ground
16	GND	Ground	37	DE	Data enable signal Note1
17	GND	Ground	38	N.C.	Non-connection
18	GND	Ground	39	VCC	Power supply Note3
19	G0	Green data (LSB)	40	VCC	Power supply Note3
20	G1	Green data	41	DPS	Scan direction select Note2
21	G2	Green data			

LSB: Least Significant Bit

MSB: Most Significant Bit

Note 1: DE / This function recognizes Fixed or DE mode when Vsync rises.

Low = DE mode

High = Fixed mode

Note 2: DPS / DPS changes scan direction ( normal scan and reverse scan).

Low or open = Normal scan

High = Reverse scan

See 14. DISPLAY POSITIONS about the scan directions.



Note 3: All VCC terminals should be connected to 3.3V or 5.0V.



## (2) Lamp connector

CN2 socket: BHR-03VS-1  
 Adaptable plug: SM03 (4.0) B-BHS-TB  
 Supplier: J.S.T TRADING COMPANY, LTD.

Pin No.	Symbols	Function
1	V <sub>LOW</sub>	Low voltage terminal
2	V <sub>HIGH</sub>	High voltage terminal
3	V <sub>HIGH</sub>	High voltage terminal

Remark: V<sub>HIGH</sub> and V<sub>LOW</sub> must be connected correctly. If you make a mistake to connect, you will get hurt and the module will break.

## 【Connection of recommended Inverter: 121PW111 (NEC)】

CN1 socket

Part No. : LZ-5P-SL-SMT  
 Adaptable plug: LZ-5S-SC3  
 Supplier : Japan Aviation Electronics Industry Limited (JAE)

Pin No.	Symbols	Remarks
1	V <sub>DDB</sub>	12V ± 5%
2	V <sub>DDB</sub>	12V ± 5%
3	GN <sub>DB</sub>	Ground
4	GN <sub>DB</sub>	Ground
5	BR <sub>THL</sub>	Luminance control Note 1

Note 1: BR<sub>THL</sub> = +5V or Open : Luminance (100%)  
 BR<sub>THL</sub> = Low (GN<sub>DB</sub> level): Luminance (20% Typ.)

CN3 socket

Part No. : IL-Z-3PL-SMTY  
 Adaptable plug: IL-Z-3S-S125C3  
 Supplier : Japan Aviation Electronics Industry Limited (JAE).

Pin No.	Symbols	Remarks
1	BR <sub>TC</sub>	Backlight on/off Note 1
2	BR <sub>TH</sub>	Luminance control input Note 2,3
3	BR <sub>TL</sub>	Luminance control input Note 2,3

Note 1: BR<sub>TC</sub> = +5V or Open : Backlight "on"  
 BR<sub>TC</sub> = Low (GN<sub>DB</sub> level) : Backlight "off"

Note 2: A way of luminance control by a variable resistor.

This way works when BR<sub>THL</sub> (No.5 pin) of CN1 is opened.

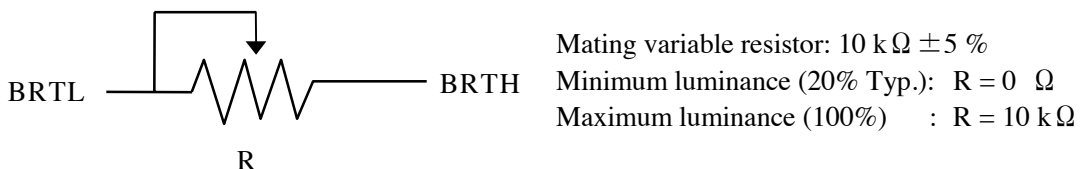

Note 3: A way of luminance control by a voltage.

BR<sub>TL</sub> and BR<sub>THL</sub> are opened.

The range of input voltage between BR<sub>TH</sub> and GN<sub>DB</sub> is as follows.

Minimum luminance (20% Typ.): 3.45V  
 Maximum luminance (100%) : ≤ 1.0 V

(3) Connector locations

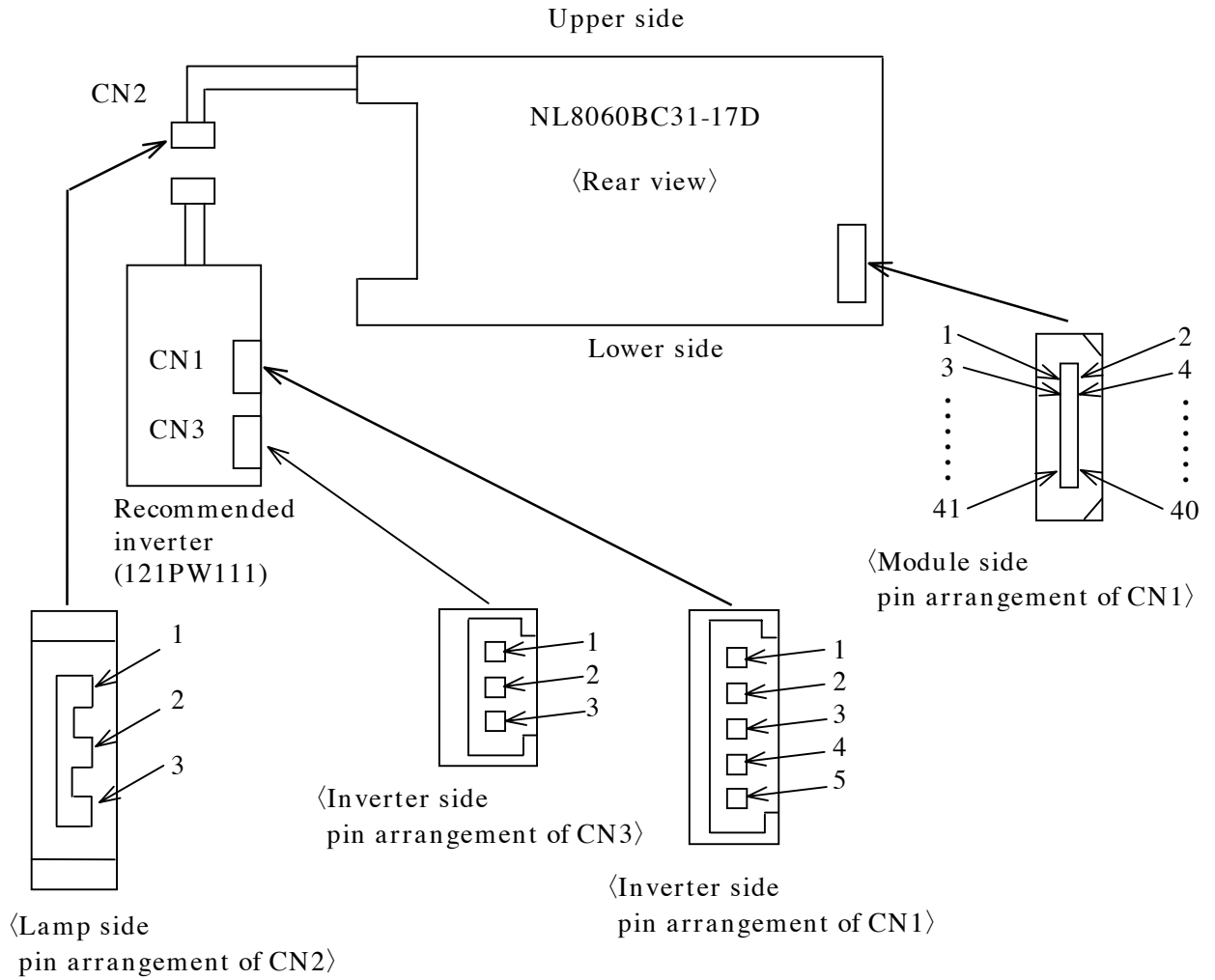

## 12. DISPLAY COLORS vs. INPUT DATA SIGNALS

Display colors		Data signal(0: Low level, 1: High level)																	
		R5	R4	R3	R2	R1	R0	G5	G4	G3	G2	G1	G0	B5	B4	B3	B2	B1	B0
Basic colors	Black	0	0	0	0	0	0	0	0	0	0	0	0	0	0	0	0	0	0
	Blue	0	0	0	0	0	0	0	0	0	0	0	0	1	1	1	1	1	1
	Red	1	1	1	1	1	1	0	0	0	0	0	0	0	0	0	0	0	0
	Magenta	1	1	1	1	1	1	0	0	0	0	0	0	1	1	1	1	1	1
	Green	0	0	0	0	0	0	1	1	1	1	1	1	0	0	0	0	0	0
	Cyan	0	0	0	0	0	0	1	1	1	1	1	1	1	1	1	1	1	1
	Yellow	1	1	1	1	1	1	1	1	1	1	1	1	0	0	0	0	0	0
	White	1	1	1	1	1	1	1	1	1	1	1	1	1	1	1	1	1	1
Red grayscale	Black	0	0	0	0	0	0	0	0	0	0	0	0	0	0	0	0	0	0
	dark	0	0	0	0	0	1	0	0	0	0	0	0	0	0	0	0	0	0
	↑																		
	↓																		
	bright	1	1	1	1	0	1	0	0	0	0	0	0	0	0	0	0	0	0
	Red	1	1	1	1	1	1	0	0	0	0	0	0	0	0	0	0	0	0
Green grayscale	Black	0	0	0	0	0	0	0	0	0	0	0	0	0	0	0	0	0	0
	dark	0	0	0	0	0	0	0	0	0	0	0	1	0	0	0	0	0	0
	↑																		
	↓																		
	bright	0	0	0	0	0	0	1	1	1	1	0	1	0	0	0	0	0	0
	Green	0	0	0	0	0	0	1	1	1	1	1	1	0	0	0	0	0	0
Blue grayscale	Black	0	0	0	0	0	0	0	0	0	0	0	0	0	0	0	0	0	0
	dark	0	0	0	0	0	0	0	0	0	0	0	0	0	0	0	0	1	0
	↑																		
	↓																		
	bright	0	0	0	0	0	0	0	0	0	0	0	0	1	1	1	1	0	1
	Blue	0	0	0	0	0	0	0	0	0	0	0	0	1	1	1	1	1	0

Remark: Colors are developed in combination with 6-bit signals (64 steps in grayscale) of each primary red, green, and blue color. This process can result in up to 262,144 (64 × 64 × 64) colors.

### 13. INPUT SIGNAL TIMINGS

#### (1) Input signal specifications

Parameters		Symbols	Min.	Typ.	Max.	Unit	Remarks
CLK	Frequency	1/tc	34.0	38.362	40.0	MHz	26.067ns(Typ.)
	Duty	tch/tc	0.4	0.5	0.6	—	—
	Rise, fall	Tcrf	—	—	10	ns	—
Hsync	Period	Th	24.0	26.693	—	$\mu$ s	37.463kHz(Typ.)
			829	1024	—	CLK	
	Display period	Thd	800			CLK	—
	Front-porch	thf	24			CLK	Fixed mode
			4	24	—	CLK	DE mode
	Pulse width	thp *	12	72	127	CLK	Fixed mode
			12	72	—	CLK	DE mode
	Back-porch	thb *	73	128	198	CLK	Fixed mode
			13	128	509	CLK	DE mode
	* thp + thb		200			CLK	Fixed mode
			25	200	511	CLK	DE mode
	CLK-Hsync timing	tchc	10	—	—	ns	—
	Hsync-CLK timing	thcs	8	—	—	ns	—
	Hsync-Vsync timing	tvhh	1	—	—	CLK	—
	Vsync-Hsync timing	tvhs	15	—	—	ns	—
Rise, fall	thrf	—	—	10	ns	—	
Vsync	Period	tv	16.1	16.683	17.2	ms	59.95Hz(Typ.)
			603	625	—	H	
	Display period	tvd	600			H	—
	Front-porch	tvf	1			H	Fixed mode
			1	1	—	H	DE mode
	Pulse width	tvp **	1	2	23	H	Fixed mode
			1	2	—	H	DE mode
	Back-porch	tvb **	1	22	23	H	Fixed mode
1			22	—	H	DE mode	
** tvp + tvb		24			H	Fixed mode	
		2	24	254	H	DE mode	
Rise, fall	tvrf	—	—	10	ns	—	
DATA R0-R5 G0-G5 B0-B5	CLK-DATA timing	tds	8	—	—	ns	—
	DATA-CLK timing	tdh	10	—	—	ns	
	Rise, fall	tdrf	—	—	10	ns	
DE	DE-CLK timing	tes	8	—	—	ns	—
	CLK-DE timing	teh	10	—	—	ns	
	Rise, fall	terf	—	—	10	ns	

Remark: All parameters should be kept within the specified range.

## (2) Definition of input signal timings

&lt;Vertical&gt;

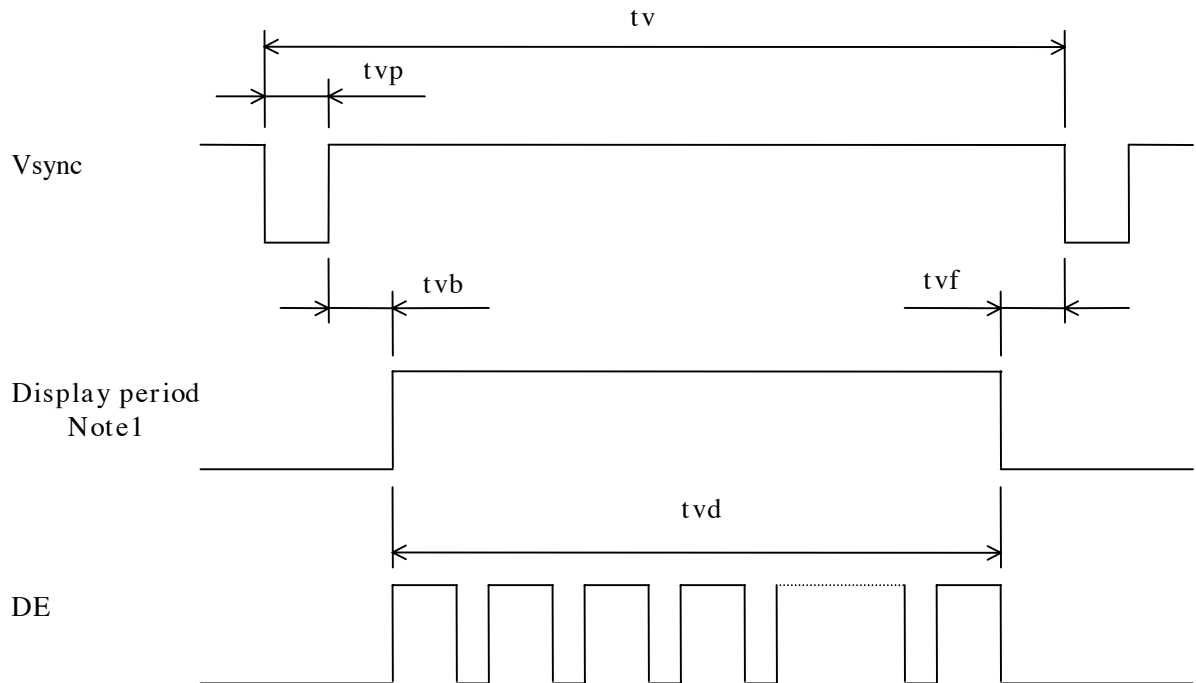

&lt;Horizontal&gt;

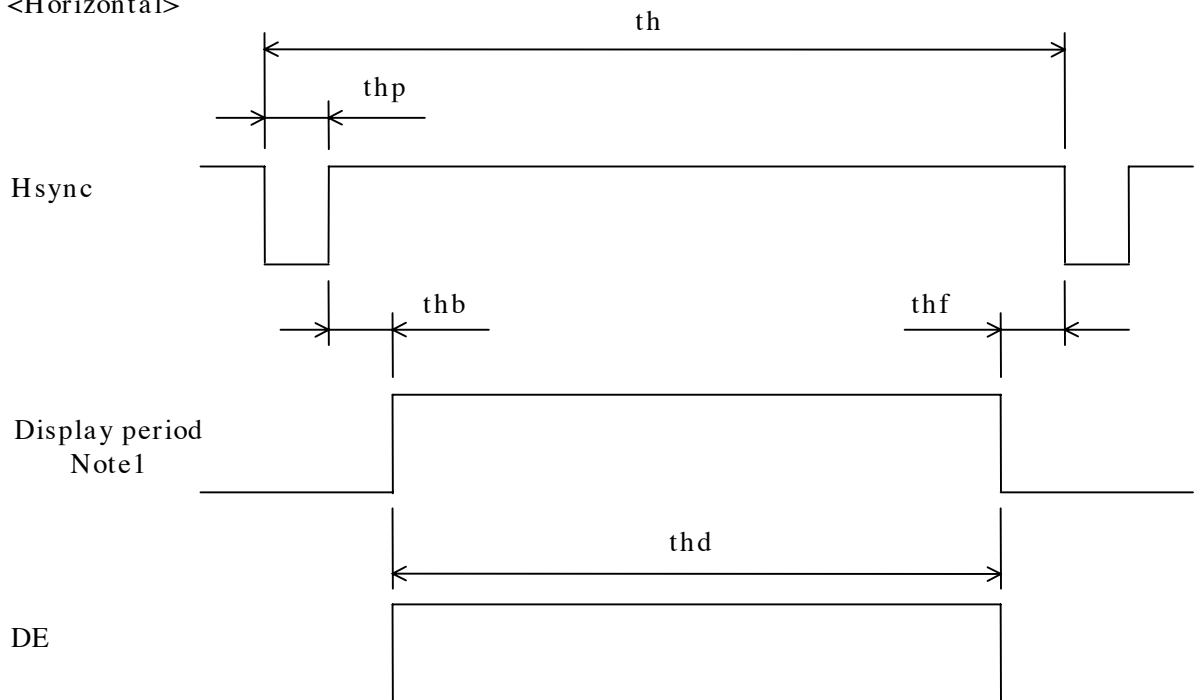

Note1: These do not exist as signals.

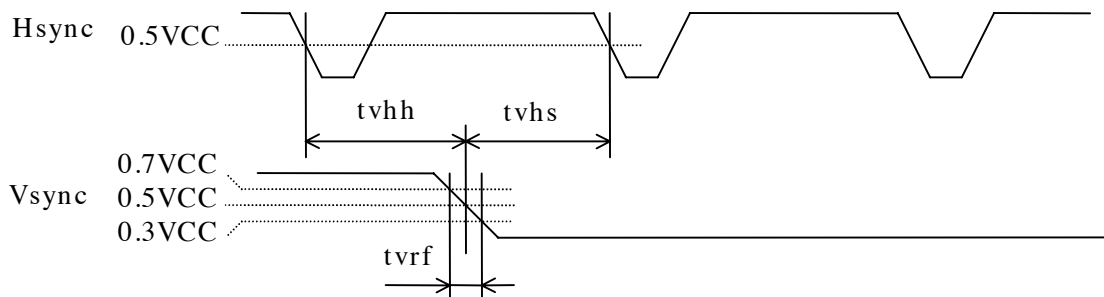
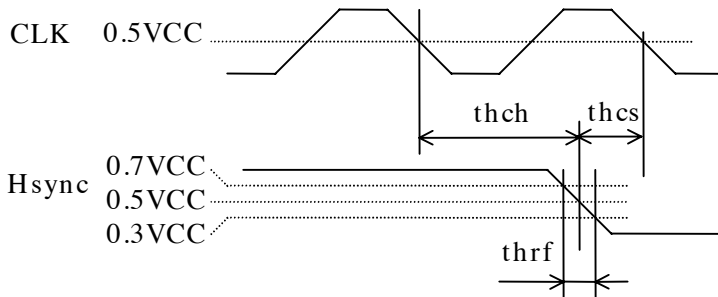
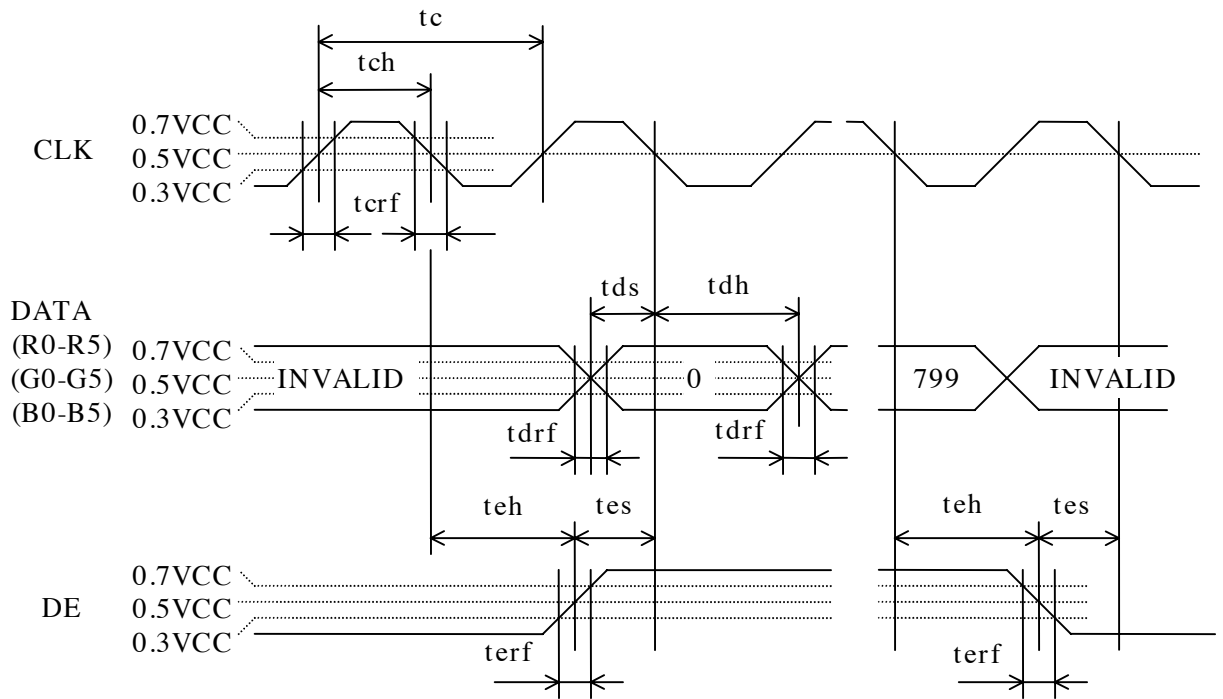

(3) Input signal timing chart  
 (a) Fixed timing mode

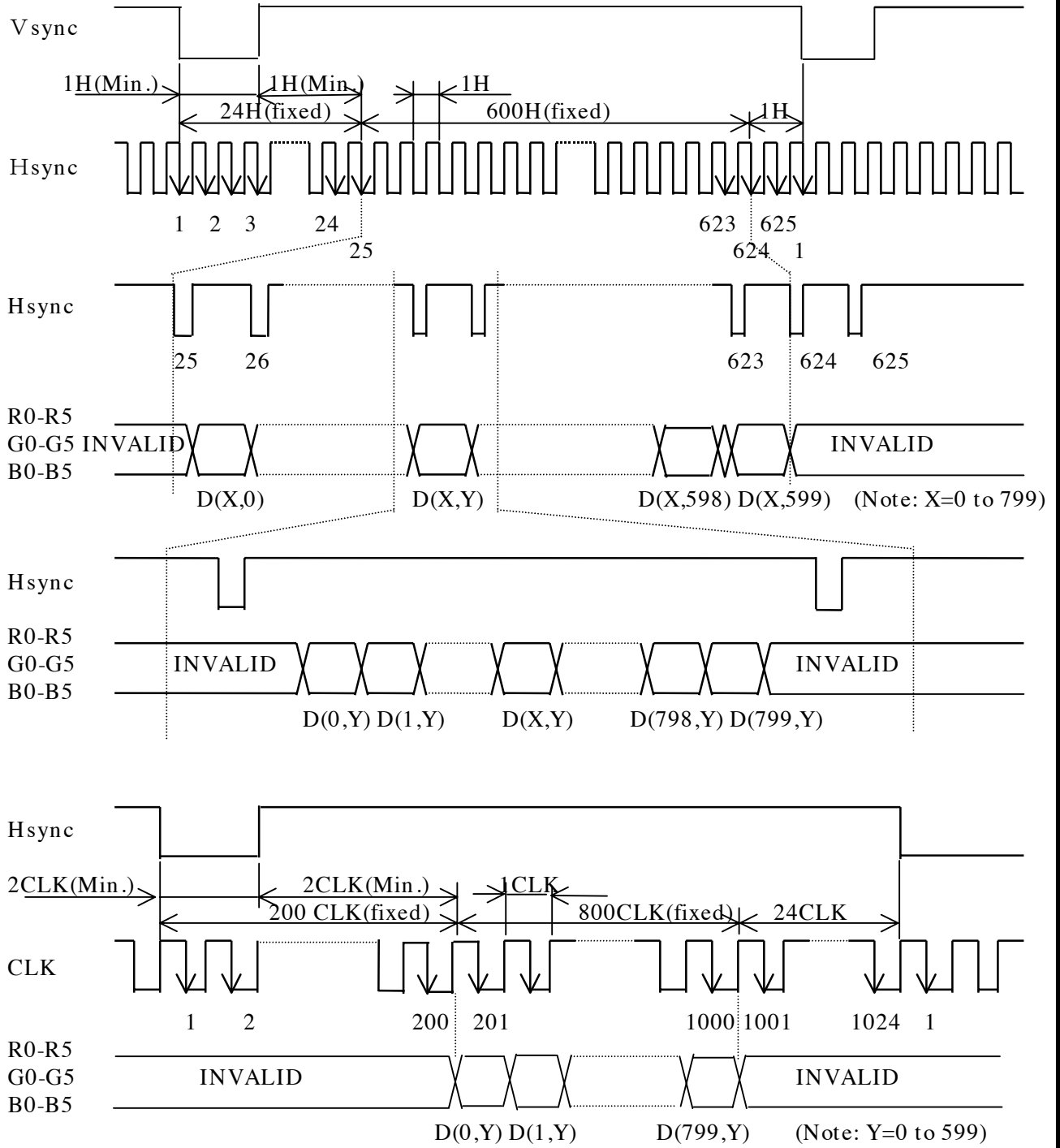

(b) DE mode

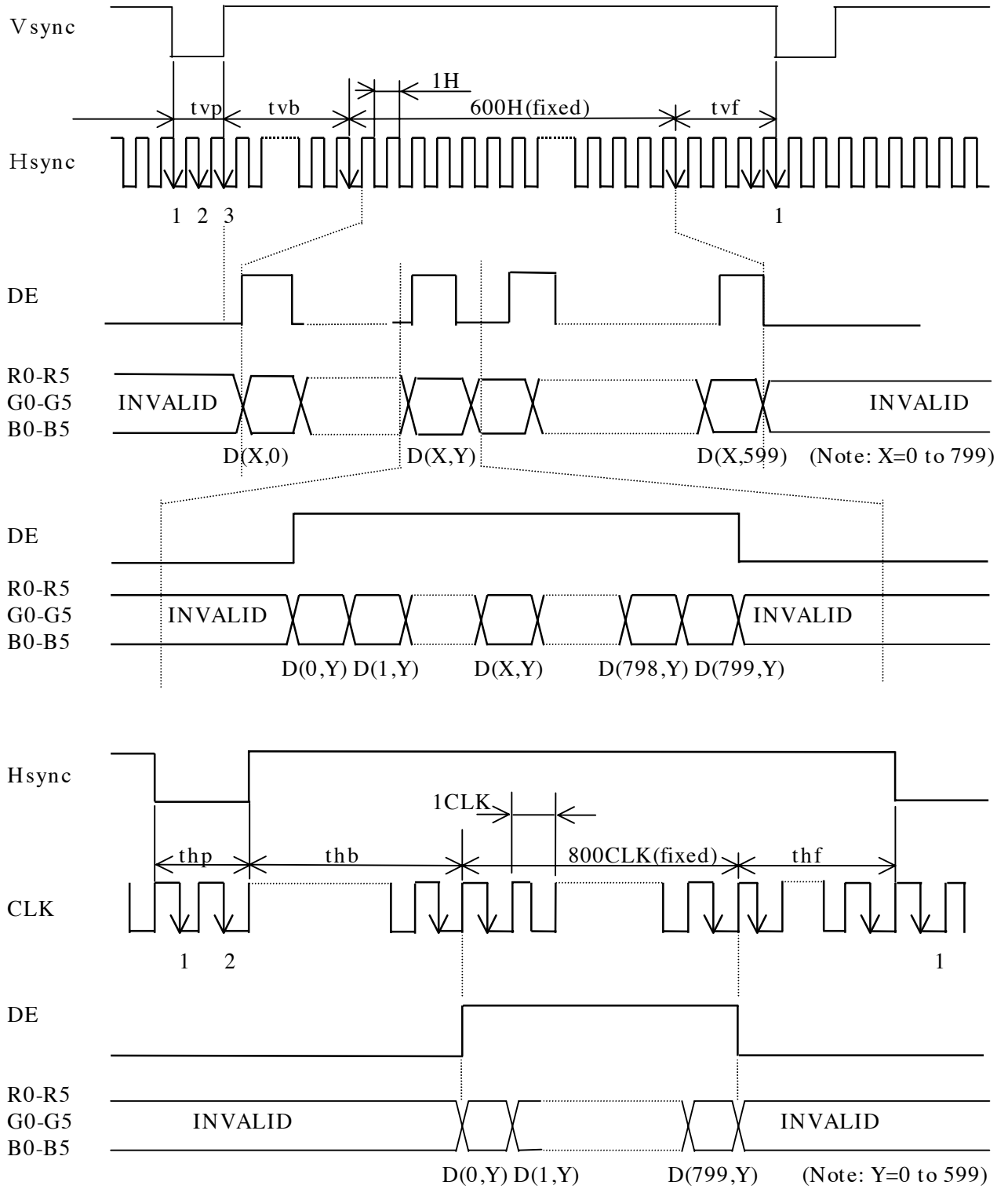



**14.DISPLAY POSITIONS**

Normal scan (DPS= "Low" or "Open" )

D( 0, 0)	D( 1, 0)	...	D( X, 0)	...	D(798, 0)	D(799, 0)
D( 0, 1)	D( 1, 1)	...	D( X, 1)	...	D(798, 1)	D(799, 1)
•	•	•	•	•	•	•
•	•	•••	•	•••	•	•
•	•	•	•	•	•	•
D( 0, Y)	D( 1, Y)	...	D( X, Y)	...	D(798, Y)	D(799, Y)
•	•	•	•	•	•	•
•	•	•••	•	•••	•	•
•	•	•	•	•	•	•
D( 0, 598)	D( 1, 598)	...	D( X, 598)	...	D(798, 598)	D(799, 598)
D( 0,599)	D( 1,599)	...	D( X,599)	...	D(798,599)	D(799,599)

Reverse scan (DPS= "High")

D( 799, 599)	D( 798, 599)	...	D( X, 599)	...	D( 1, 599)	D( 0, 599)
D( 799, 598)	D( 798, 598)	...	D( X, 598)	...	D( 1, 598)	D( 0, 598)
•	•	•	•	•	•	•
•	•	•••	•	•••	•	•
•	•	•	•	•	•	•
D( 799, Y)	D( 798, Y)	...	D( X, Y)	...	D( 1, Y)	D( 0, Y)
•	•	•	•	•	•	•
•	•	•••	•	•••	•	•
•	•	•	•	•	•	•
D( 799, 1)	D( 798, 1)	...	D( X, 1)	...	D( 1, 1)	D( 0, 1)
D( 799, 0)	D( 798, 0)	...	D( X, 0)	...	D( 1, 0)	D( 0, 0)

Remark: Below drawings show relations between the scan direction and the viewing direction.

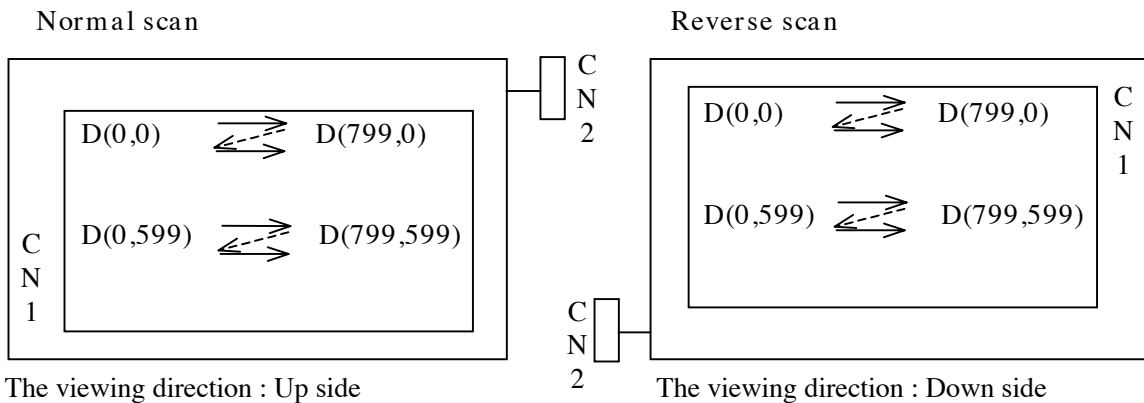

## 15. OPTICAL CHARACTERISTICS

(Ta = 25 °C, Note 1)

Parameters	Symbols	Conditions	Min.	Typ.	Max.	Unit	Remarks
Contrast ratio	CR	Note 4	200	350	—	—	Note 3
Luminance	Lumax	Note 4	270	350	—	cd/m <sup>2</sup>	Note 2
Luminance uniformity	—	Max. / Min.	—	—	1.4	—	Note 7

Reference data

(Ta = 25 °C, Note 1)

Parameters	Symbols	Conditions	Min.	Typ.	Max.	Unit	Remarks	
Color gamut	C	To NTSC	35	43	—	%	Note 4	
Viewing Angle Range (CR>10)	Horizontal	$\theta_{x+}$	CR>10, $\theta_y = \pm 0^\circ$	45	55	—	deg.	Note 5
		$\theta_{x-}$		45	55	—	deg.	
	Vertical	$\theta_{y+}$	CR>10, $\theta_x = \pm 0^\circ$	30	40	—	deg.	
		$\theta_{y-}$		40	50	—	deg.	
Viewing Angle Range (CR>5)	Horizontal	$\theta_{x+}$	CR>5, $\theta_x = \pm 0^\circ$	—	70	—	deg.	
		$\theta_{x-}$		—	70	—	deg.	
	Vertical	$\theta_{y+}$	CR>5, $\theta_x = \pm 0^\circ$	—	45	—	deg.	
		$\theta_{y-}$		—	70	—	deg.	
Response time	Ton	“White” to “Black”	—	15	40	ms	Note 6	
	Toff	“Black” to “White”	—	55	70	ms		

Note 1: VCC = 3.3V, IL= 5mA, with recommended inverter Part No.121PW111

Note 2: The luminance is measured after 20 minutes from the module works, with all pixels in “white”.  
Typical value is measured after luminance saturation.  
The luminance is measured in dark room.

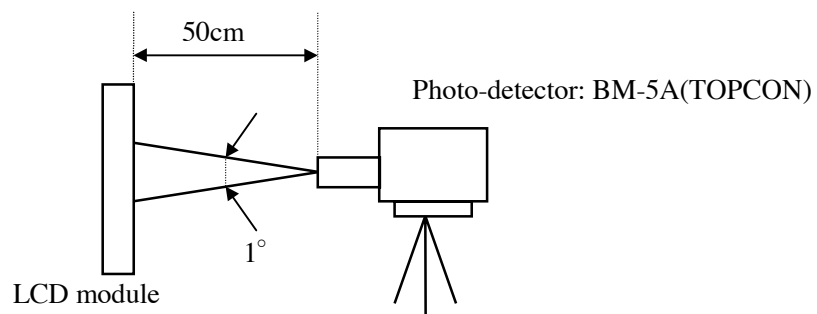

Note 3: The contrast ratio is calculated by using the following formula.

$$\text{Contrast ratio (CR)} = \frac{\text{Luminance with all pixels in "white"}}{\text{Luminance with all pixels in "black"}}$$

Note 4: Viewing angle is  $\theta_x = \pm 0^\circ$ ,  $\theta_y = \pm 0^\circ$ , At center.

Note 5: Definitions of viewing angles are as follows

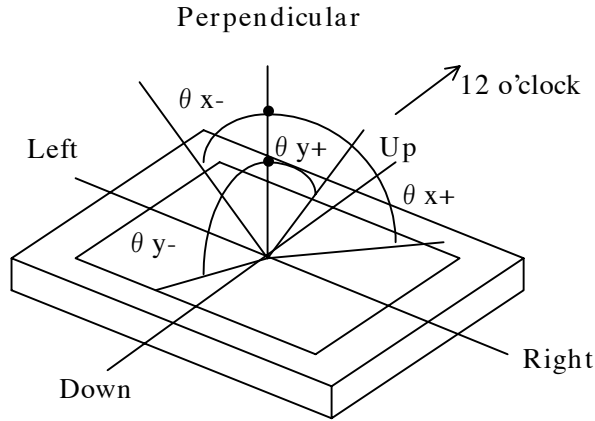

Note 6: Definitions of response time is as follows.

Photo-detector output signal is measured when the luminance changes "white" to "black" or "black" to "white".

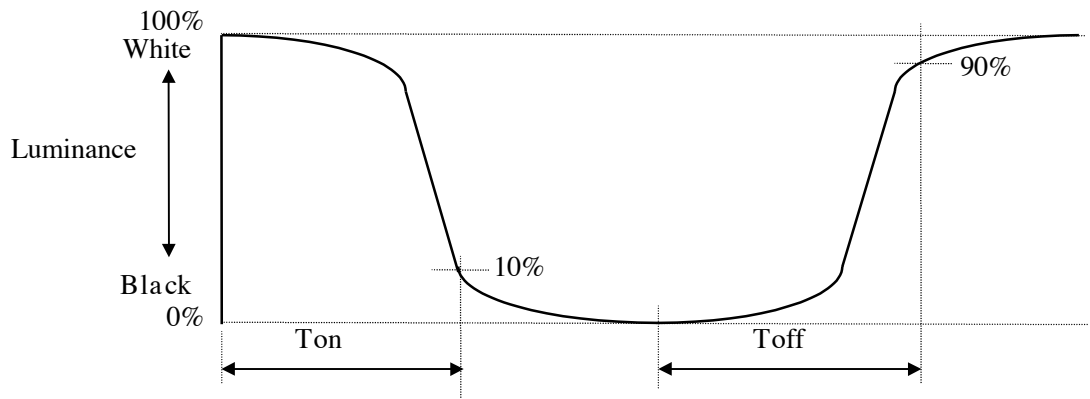

Note 7: Luminance uniformity is calculated by using the following formula.

$$\text{Luminance uniformity} = \frac{\text{Maximum luminance}}{\text{Minimum luminance}}$$

The luminance is measured at near the five points shown below.

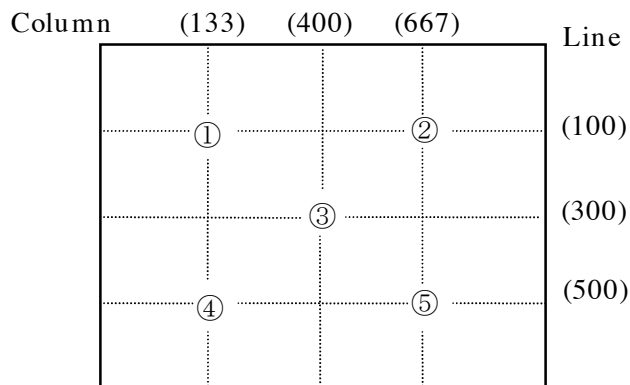

## 16. DEFECT SPECIFICATIONS

### a) Inspection conditions

Distance: The distance between the inspector's eye and the LCD panel is 20cm.





Temperature : Room temperature is  $25^{\circ}\text{C} \pm 5^{\circ}\text{C}$ .

Viewing angle and Illumination:

Display specifications:  $-20^{\circ} \leq \theta_x \leq +20^{\circ}$  ,  $0^{\circ} \leq \theta_y \leq +20^{\circ}$   
60 lx at a LCD surface

Appearance specifications:  $-45^{\circ} \leq \theta_x \leq +45^{\circ}$  ,  $-45^{\circ} \leq \theta_y \leq +45^{\circ}$   
700 lx at a operation table

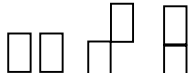
### b) Display specifications

Items	Specifications		
Line defect	Not allowed.		
Dot defect	Sub-item	Quantity	
	Bright dots Note 2 Or Dark dots Note 3	One dot $\leq 5$ Note 4	
		Linked two bright dots $\leq 2$ Note 5	
		Linked two dark dots $\leq 0$ Note 5	
		Linked three or more dots $\leq 0$ Note 5	
		Neighboring Minimum distance = 15mm	
Note 1	Bright dots + Dark dots	$\leq 10$	
 RGB Pixel	 R,G or B Dot	 e. g., Linkage	 e.g., Neighboring

Note 1: Dot defect ; Defect area  $> 1/3$  of one dot.

Dot defects include intermittent Bright and dark dot.

Note 2: Bright dots ; Bright dots are measured while the screen is black.

Note 3: Dark dots ; Dark dots are measured while the screen is illuminated with Red, Green and Blue.

Note 4: One dot ; Defect dot is isolated, not attached to other defect dots.

Note 5: Linkage ; Linked dots are consecutive.

## C) Appearance specifications

Items	Specifications		
	Measurement criteria	Quantity	
Other objects Stains Dust (dot shape)	Average diameter ( $\phi$ ) mm		
	$\phi \leq 0.2$	Allowed value	
	$0.2 < \phi < 0.3$	all allowed	
	$0.3 \leq \phi \leq 0.5$	$\leq 10$ points	
	$0.5 < \phi$	$\leq 3$ points	
	Linked other objects	0 point	
Other objects Stains Dust (line shape)	Width(W) mm	Length(L) mm	
	$W < 0.05$	—	
	$0.05 \leq W \leq 0.1$	$L < 0.7$	all allowed
		$0.7 \leq L \leq 1.0$	$\leq 4$ points
	$0.1 < W$	—	0 point
Polarizer Bubbles Wrinkles Dent Panel dent	Average diameter ( $\phi$ ) mm		
	$\phi \leq 0.5$	$\leq 2$ points	
	$0.5 < \phi$	0 point	
Polarizer scratch	Area (S) mm <sup>2</sup>		
	$S \leq 0.2$ at active area	all allowed	
	$0.2 < S$ at active area	0 point	
Form	Specified labels and parts are put.		

## 17. RELIABILITY TEST

Test items	Test condition	Judgment
High temperature / humidity operation	50±2°C, RH= 85% 240 hours, Display data is black.	Note 1
Heat cycle (operation)	① 0°C±3°C···1 hour 55°C±3°C···1 hour ② 50 cycles , 4 hours / cycle ③ Display data is black.	Note 1
Thermal shock (non-operation)	① -20°C±3°C···30 minutes 60°C±3°C···30 minutes ② 100 cycles ③ Temperature transition time is within 5 minutes.	Note 1
Vibration (non-operation)	① 5-100Hz, 19.6m/s <sup>2</sup> (2G) 1 minute / cycle, X,Y,Z direction ② 120 times each direction	Note 1 Note 2
Mechanical shock (non-operation)	① 539 m/s <sup>2</sup> (55G), 11ms X,Y,Z direction ② 5 times each direction	Note 1 Note 2
ESD (operation)	150pF, 150Ω, ±10KV 9 places on a panel Note 3 10 times each place at one-second intervals	Note 1
Dust (operation)	15 kinds of dust (JIS-Z 8901) Hourly 15 seconds stir, 8 times repeat	Note 1

Note 1: Display function is checked by the same condition as LCD module out-going inspection.

Note 2: Physical damage

Note 3: Discharge points are shown as follows.

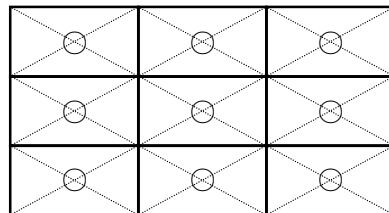

## 18. ESTIMATED LIFE-TIME OF THE BARE LAMP

	Bare Lamp	
Condition	IL= 5mArms Room temp. (25°C) , Continuous operation	Note 3
Estimated value (MTTF)	50,000h	Note
Criteria	1,2	
	Half value luminance (compared with initial value.)	

Note1: The life-time is expected value (reference).

Note2: This expected value is based on the test results with a bare lamp operation.  
The MTTF for the module might be different from these values, because of the influence of ambient and clamshell conditions.

Note3: The life-time becomes short if the module is operated under the low and high temperature environment.

## 19.GENERAL CAUTIONS

Next figures and sentences are very important, please understand these contents as follows.

	<b>CAUTION</b> This figure is a mark that you will get hurt and/or the module will have damages when you make a mistake to operate.
---	---

	This figure is a mark that you will get an electric shock when you make a mistake to operate.
---	---

	This figure is a mark that you will get hurt when you make a mistake to operate.
---	--

### CAUTIONS

#### (1) Caution when taking out the module

- ① Pick the pouch only, when taking out the module from a carrier box.

#### (2) Cautions for handling the module

- ① As the electrostatic discharges may break the LCD module, handle the LCD module with care against electrostatic discharges. Peel protection sheet out from the LCD panel surface as slowly as possible.
- ②  As the LCD panel and backlight element are made from fragile glass material, impulse and pressure to the LCD module should be avoided.
- ③ As the surface of polarizer is very soft and easily scratched, use a soft dry cloth without chemicals for cleaning.
- ④ Do not pull the interface connectors in or out while the LCD module is operating.
- ⑤ Put the module display side down on a flat horizontal plane.
- ⑥ Handle connectors and cables with care.
- ⑦ When the module is operating, do not lose CLK, Hsync, or Vsync signal. If any one or more of these signals is lost, the LCD panel would be damaged.
- ⑧ The torque for mounting screws should never exceed 0.294 N·m (3 kgf·cm).
- ⑨ Don't push or rub the surface of LCD module please.  
If you do, the scratches or the marks like rubbing marks may be left on the surface of the module.
- ⑩ Do not give the stress too much on interface connectors. The module may become function deficiency by a contact defective and damages. Pay attention to handling at the time of matching connector connection and in the connection condition.

#### (3) Cautions for the atmosphere

- ① Dew drop atmosphere must be avoided.
- ② Do not store and/or operate the LCD module in a high temperature and/or high humidity atmosphere. Storage in an anti-static pouch and under the room temperature atmosphere is recommended.
- ③ This module uses cold cathode fluorescent lamps. Therefore, the life of lamps becomes short if the module is operated under the low temperature environment.
- ④ Do not operate the LCD module in high magnetic field.

(4) Cautions for the module characteristics

- ① Do not apply any fixed pattern data for a long time to the LCD module. It may cause image sticking. Please use screen savers if the display pattern is fixed for a long time.
- ② This module has the retardation film which may cause the variation of the color hue in the different viewing angles. The ununiformity may appear on the screen under the high temperature operation.
- ③ The light vertical stripe may be observed depending on the display pattern. This is not defects nor malfunctions.
- ④ The noise from the inverter circuit may be observed in the luminance control mode. This is not defects nor malfunctions.

(5) Other cautions

- ① Do not disassemble and/or reassemble LCD module.
- ② Do not readjust variable resistors nor switches in the module.
- ③ When returning the module for repair etc., please pack the module properly to avoid any damages. We recommend the original shipping packages.

Liquid Crystal Display has the following specific characteristics. These are not defects nor malfunctions.

The optical characteristics of this module may be affected by the ambient temperature. This module has cold cathode tube for backlight. Optical characteristics, like luminance or uniformity, will be changed by the progress in time.

Uneven brightness and/or small spots may be observed depending on different display patterns.



20.OUTLINE DRAWINGS.  
20.1.FRONT SIDE (Unit in mm)

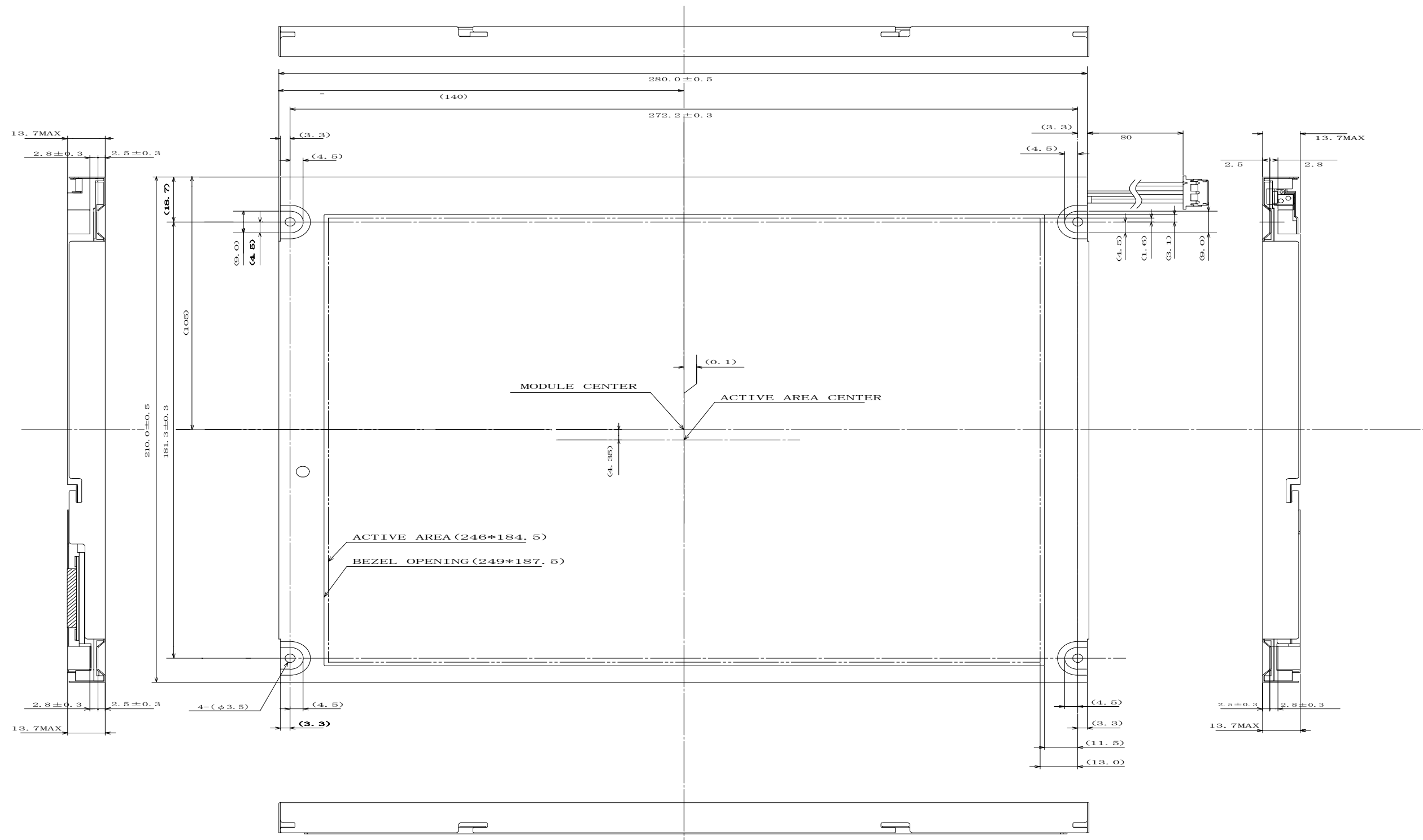

Note1 : The value in parentheses are for reference.  
Note2 : The torque to mounting screw never exceed  $0.294\text{N}\cdot\text{m}$  ( $3\text{kgf}\cdot\text{cm}$ )

20.2. REAR SIDE (Unit in mm)

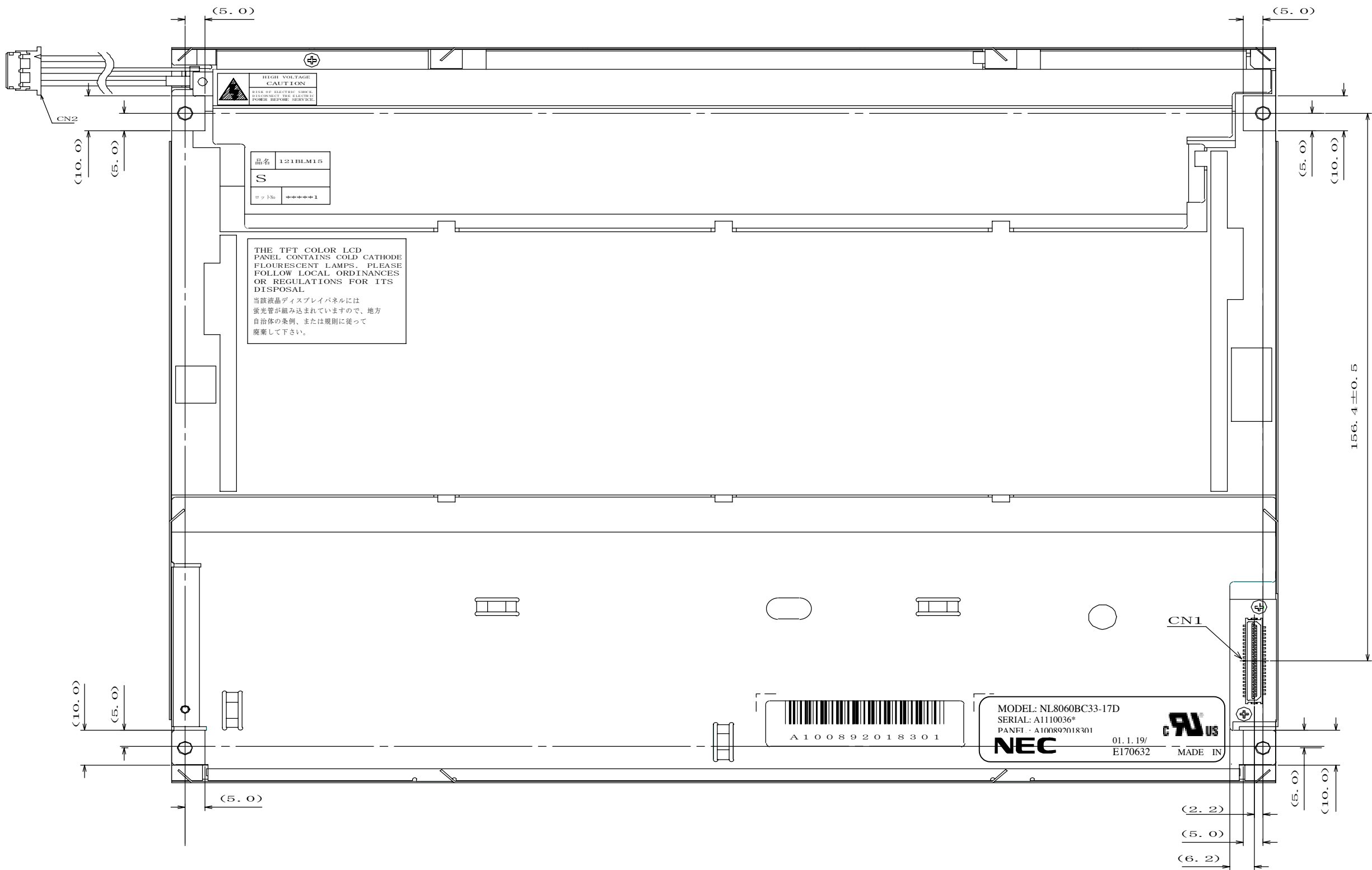

Note1: The value in parentheses are for reference.  
 Note2: The torque to mounting screw never exceed 0.294 N·m(3kgf·cm)

## Revision History

Rev.	Prepared Date	Revision contents	Approved	Checked	Prepared	Issued Date
1	Jan. 24, 2001	No. DOD-N-0020	<i>st. horigawa</i>	<i>T. Kusanagi</i>	<i>A. Kumano</i>	